



BUNZL **LOCKHART**
Catering Equipment
Exclusive Brands



CONTENTS











BUNZL LOCKHART Catering Equipment Exclusive Brands



We're delighted to present to you our NEW 'Exclusive Brands' catalogue. Lockhart Exclusive Brands are designed to provide our customers with affordable innovation, whatever their specific requirements. By combining our expert knowledge of the latest industry trends with a truly global sourcing capability we are able to offer customers a unique combination of cutting-edge design and great value for money.

The result is a range of 19 brands designed to help you bring innovation and inspiration to the preparation and presentation of food.

We hope that you like what you see here!

	G R E A T W H I T E	TABLEWARE	04		BARWARE	126
	SUPERWHITE	TABLEWARE	08		BUFFET	136
	ARTISAN	TABLEWARE	17		BUFFET	150
	Crème	TABLEWARE	51		BUFFET	163
	Ariane <small>fine porcelain</small>	TABLEWARE	70		BUFFET	174
	Signature COLLECTION	CUTLERY	82		CHEFS CLOTHING	188
	twentyeight	CUTLERY	93		KITCHEN UTENSILS	200
	GLACIAL ^{eco}	GLASSWARE	105		REFRIGERATION	226
	GLACIAL	GLASSWARE	117		CATERING APPLIANCES	252
					FABRICATION & SHELVING	287

TABLEWARE

TABLEWARE

))) GREAT WHITE 04

SUPERWHITE 08

o ARTISAN 17

Crème 51

Ⓐ Ariane fine porcelain 70

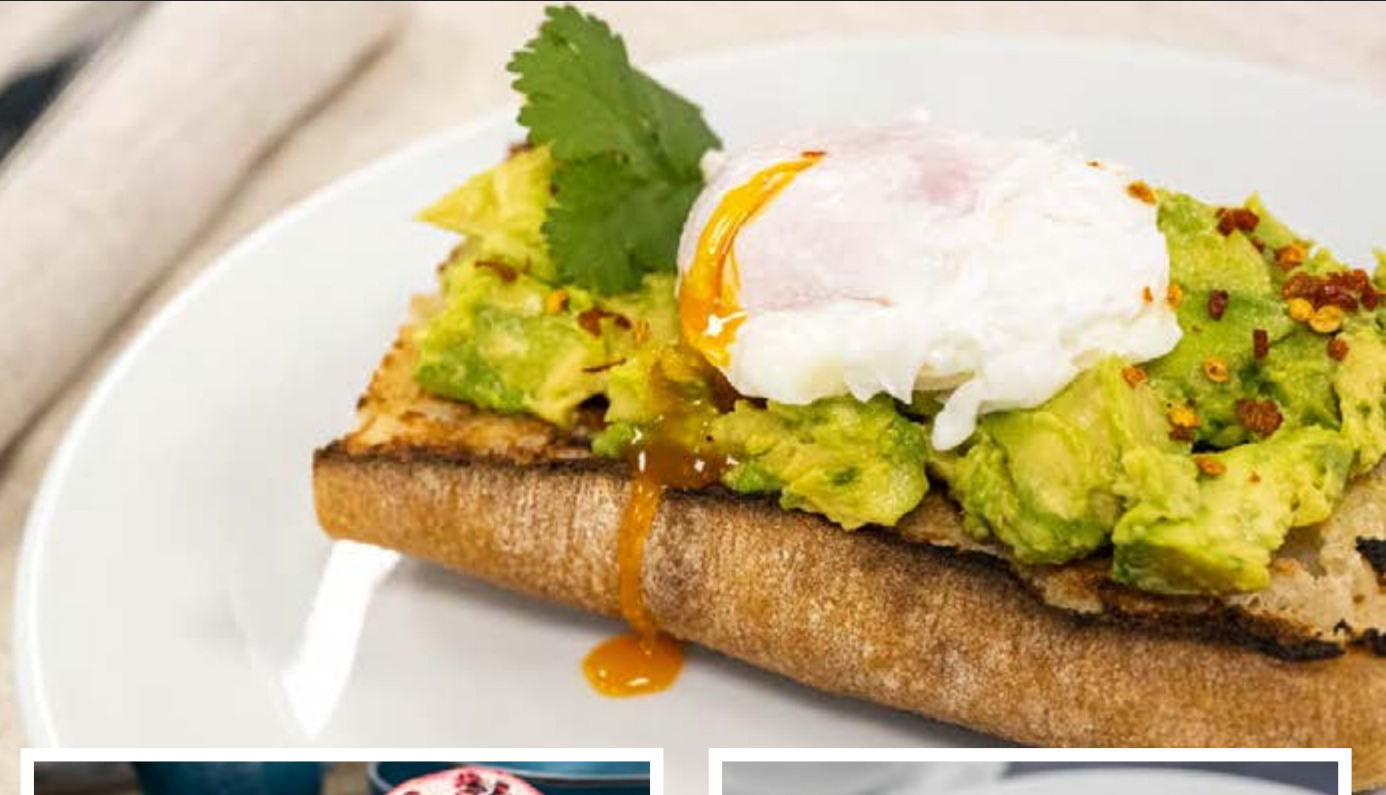

GREAT WHITE - TABLEWARE



G R E A T
W H I T E



CONTENTS



Great White

Great White offers an exclusive range of quality vitrified porcelain tableware at the most competitive prices. In fact, Great White is up to 70% cheaper than other leading brands. Manufactured to BS4034 vitrified hotelware standards, the Great White range includes plates, cups, mugs, saucers, bowls, teapots, jugs and salt and pepper pots.

Every item is dishwasher, oven and freezer safe as well as thermal shock resistant. Plates, saucers, bowls, oval dishes, cups and mugs are also covered by a Lifetime Edge Chip Warranty. Please see lockhart.co.uk for full details.



PLATES & BOWLS



01

Coupe Plates

- 01 **PRBG828** Coupe Plate 10", 26cm Case Qty 6
- 01 **PRBG827** Coupe Plate 8½", 22cm Case Qty 6
- 01 **PRBG826** Coupe Plate 7", 18cm Case Qty 6



02

Winged Plates

- 02 **PRBG824** Winged Plate 12", 31cm Case Qty 6
- 02 **PRBG823** Winged Plate 10", 26cm Case Qty 6
- 02 **PRBG822** Winged Plate 9", 23cm Case Qty 6
- 02 **PRBG821** Winged Plate 6½", 17cm Case Qty 12



03

Oval Plates

- 03 **PRBG831** Coupe Plate 12", 30cm Case Qty 6
- 03 **PRBG830** Coupe Plate 11", 28cm Case Qty 6
- 03 **PRBG829** Coupe Plate 9½", 24cm Case Qty 6



04

Narrow Rim Plates

- 04 **PRBG856** Narrow Rim Plate 11", 28cm Case Qty 6
- 04 **PRBG855** Narrow Rim Plate 10¼", 25cm Case Qty 6
- 04 **PRBG854** Narrow Rim Plate 9½", 24cm Case Qty 6
- 04 **PRBG853** Narrow Rim Plate 8½", 22cm Case Qty 6
- 04 **PRBG852** Narrow Rim Plate 6¼", 16cm Case Qty 6



05



06



07



08



09

Bowls

- 05 **PRBG825** Pasta Dish Traditional 12", 30cm Case Qty 6
- 06 **PRBG832** Soup Plate 9", 23cm Case Qty 6
- 07 **PRBG857** Lugged Soup Bowl 10oz, 28cl Case Qty 12
- 08 **PRBG833** Stonerim Fruit Bowl 6", 16cm Case Qty 6
- 09 **PRBG834** Oatmeal Bowl 6", 16cm Case Qty 6



10

11

Salt & Pepper Pots

- 10 **PRBG835** Pepper Pot 3", 8cm Case Qty 12
- 11 **PRBG836** Salt Pot 3", 8cm Case Qty 12

BEVERAGE



Coffee Cups & Saucers

- | | | | |
|----|----------------|---------------------------|-------------|
| 01 | PRBG842 | Coffee Cup 9oz, 25cl | Case Qty 12 |
| 01 | PRBG843 | Coffee Cup 12oz, 34cl | Case Qty 12 |
| 01 | PRBG844 | Coffee Cup 14oz, 40cl | Case Qty 12 |
| 02 | PRBG839 | Coffee Saucer 6¼", 16cm | Case Qty 12 |
| 03 | PRBG841 | Espresso Cup 3oz, 9cl | Case Qty 12 |
| 04 | PRBG837 | Espresso Saucer 4½", 12cm | Case Qty 12 |



Stacking Tea Cup & Saucer

- | | | | |
|----|----------------|----------------------------|-------------|
| 05 | PRBG840 | Stacking Tea Cup 7oz, 20cl | Case Qty 12 |
| 06 | PRBG838 | Tea Saucer 5¾", 15cm | Case Qty 12 |



Latte Mugs

- | | | | |
|----|----------------|-----------------------|-------------|
| 07 | PRBG846 | Latte Mug 16oz, 44cl | Case Qty 12 |
| 08 | PRBG845 | Latte Mug 12oz, 34cl | Case Qty 12 |
| 09 | PRBM117 | Latte Mug, 10oz, 28cl | Case Qty 12 |



Mugs

- | | | | |
|----|----------------|-------------------------|-------------|
| 10 | PRBG847 | Mug 12oz, 34cl | Case Qty 12 |
| 11 | PRBG848 | Stacking Mug 12oz, 34cl | Case Qty 12 |



Jugs, Pots & Bowl

- | | | | |
|----|----------------|-----------------------|-------------|
| 12 | PRBG850 | Coffee Pot 11oz, 31cl | Case Qty 4 |
| 13 | PRBG851 | Tea Pot 16oz, 46cl | Case Qty 4 |
| 14 | PRBG858 | Sugar Bowl 9oz, 25cl | Case Qty 12 |
| 15 | PRBG849 | Jug 5oz, 14cl | Case Qty 6 |
| 16 | PRBG859 | Milk Jug 13¼oz, 5cl | Case Qty 12 |



SUPERWHITE - TABLEWARE

SUPERWHITE



CONTENTS



Superwhite

Superwhite is strong, durable and stylish. If you need a range of tableware, buffetware and oven-to-tableware that can cope with all the demands of the modern catering environment and still look stunning year after year, then Superwhite is the answer.

Manufactured to BS4034 vitrified hotelware standards, Superwhite products are strong, durable and offer outstanding value for money. Plates, saucers, bowls, oval dishes, cups and mugs are also covered by a Lifetime Edge Chip Warranty. Please see lockhart.co.uk/superwhite for full details.



HEAT & SHOCK RESISTANT



OVEN SAFE



FREEZER SAFE



MICROWAVE SAFE



LIFETIME EDGE CHIP WARRANTY



DISHWASHER SAFE



CHIP RESISTANT ROLLED EDGES

SUPERWHITE CAFÉ

Superwhite Café

A striking range of coloured crockery to add vibrance to hot beverage service.



Sky Blue Sage Green Grey White Black

	Sky Blue	Sage Green	Grey	White	Black			
01	BN386	BN390	BN394	BN398	BN402	Bowl Shaped Cup - 8oz, 230ml	Case Qty 12	
02	BN387	BN391	BN395	BN399	BN403	Bowl Shaped Cup - 10oz, 285ml	Case Qty 12	
03	BN388	BN392	BN396	BN400	BN404	Bowl Shaped Cup - 12oz, 340ml	Case Qty 12	
04	BN389	BN393	BN397	BN401	BN405	Bowl Shaped Cup - 16oz, 454ml	Case Qty 6	
05	BN410	BN412	BN414	BN416	BN418	Tulip Shaped Cup - 3oz, 85ml	Case Qty 12	
06	BN411	BN413	BN415	BN417	BN419	Tulip Shaped Cup - 6oz, 170ml	Case Qty 12	



Sky Blue Sage Green Grey White Black

	Sky Blue	Sage Green	Grey	White	Black		
07	BN450	BN451	BN452	BN453	BN454	Double Well Saucer - 6.1", 15.5cm	Case Qty 12
08	BN438	BN439	BN440	BN441	BN442	Single Well Saucer - 4.3", 11cm	Case Qty 12
09	BN444	BN445	BN446	BN447	BN448	Single Well Saucer - 5.5", 14cm	Case Qty 12
10	BN422	BN425	BN428	BN431	BN432	Latte Mug - 10oz, 285ml	Case Qty 12
11	BN423	BN426	BN429	BN501	BN433	Latte Mug - 12oz, 340ml	Case Qty 12
12	-	BN427	BN430	BN502	BN434	Latte Mug - 16oz, 454ml	Case Qty 6



SAUCER COMPATIBILITY GUIDE

Double Well Saucer

fits all sizes of bowl shaped cups & mugs

Single Well Saucer

11cm / 4.3" to fit 3oz Tulip Cup
14cm / 5.5" to fit 6oz Tulip Cup

Stacking Teapots

13	BN456	15oz, 425ml - White	Case Qty 4
13	BN457	30oz, 850ml - White	Case Qty 4



BEVERAGE



SAUCER COMPATIBILITY GUIDE
 BH559 Fits, BH562
 BH560 Fits, BH565, BH564
 BH558 Fits BH563

Cups, Saucers & Mugs

- | | | | | | |
|----|--------------------------------------------------|-------------|----|----------------------------------------------------|-------------|
| 01 | BH562 Stacking Tea Cup 7oz, 20cl | Case Qty 12 | 06 | BH558 Single Well Espresso Saucer 4½", 12cm | Case Qty 12 |
| 02 | BH559 Double Well Tea Saucer 5¾", 15cm | Case Qty 12 | 07 | BH568 Latte Mug 16oz, 44cl | Case Qty 12 |
| 03 | BH564 Coffee Cup 9oz, 25cl | Case Qty 12 | 07 | BH567 Latte Mug 12oz, 34cl | Case Qty 12 |
| 03 | BH565 Coffee Cup 12oz, 34cl | Case Qty 12 | 08 | BH570 Stacking Mug 12oz, 34cl | Case Qty 12 |
| 04 | BH560 Single Well Coffee Saucer 6¼", 16cm | Case Qty 12 | 09 | BH569 Mug 12oz, 34cl | Case Qty 12 |
| 05 | BH563 Espresso Cup 3oz, 9cl | Case Qty 12 | 10 | BH496 Rounded Square Mug 9oz, 25cl | Case Qty 12 |



PLATES



01

Narrow Rim Plates

- 01 **BH580** Narrow Rim Plate 10¼", 26cm Case Qty 6
- 01 **BH579** Narrow Rim Plate 9½", 24cm Case Qty 6
- 01 **BH578** Narrow Rim Plate 8½", 22cm Case Qty 6
- 01 **BH577** Narrow Rim Plate 6¼", 16cm Case Qty 12



06

Oval Plates

- 06 **BH548** Oval Plate 14", 36cm Case Qty 6
- 06 **BH547** Oval Plate 12", 30cm Case Qty 6
- 06 **BH545** Oval Plate 9½", 24cm Case Qty 6



02



03



04



05

Coupe Plates

- 02 **BH542** Coupe Plate 12", 30cm Case Qty 6
- 02 **BH541** Coupe Plate 10", 26cm Case Qty 6
- 02 **BH540** Coupe Plate 8½", 22cm Case Qty 6
- 02 **BH539** Coupe Plate 7", 18cm Case Qty 6
- 03 **BH586** Deep Coupe Plate 8", 20cm Case Qty 6
- 03 **BH543** Deep Coupe Plate 10", 26cm Case Qty 6

Winged Plates

- 04 **BH533** Winged Plate 12", 30cm Case Qty 6
- 04 **BH532** Winged Plate 10", 26cm Case Qty 6
- 04 **BH531** Winged Plate 9", 23cm Case Qty 6
- 04 **BH530** Winged Plate 6½", 17cm Case Qty 12
- 05 **BH536** Winged Pasta Dish 10", 26cm Case Qty 6



07



08

Speciality Plate

- 07 **BH550** Soup Plate 9", 23cm Case Qty 6

Pasta Plate

- 08 **BH538** Pasta Dish 12", 30cm Case Qty 6

BOWLS



01



02



03



04



07



08



09

Round Bowls

07	BN461	12cm / 4.75" - 254ml / 9 fl oz	Case Qty 6
08	BN462	14cm / 5.50" - 397ml / 14 fl oz	Case Qty 6
09	BN463	16cm / 6.25" - 625ml / 22 fl oz	Case Qty 6

Bowls

01	BH552	Oatmeal Bowl 6", 16cm	Case Qty 6
02	BH551	Stone Rim Fruit Bowl 6", 16cm	Case Qty 6
03	BH587	Lugged Soup Bowl 4 1/4", 11cm, 10oz, 28cl	Case Qty 12
04	BH620	Lion Head Soup Bowl 4", 10.5cm, 18oz, 51cl	Case Qty 6



05



06

Flared Bowls

05	BN458	12cm / 4.75" - 425ml / 15fl oz	Case Qty 6
06	BN460	16cm / 6.25" - 625ml / 22 fl oz	Case Qty 6

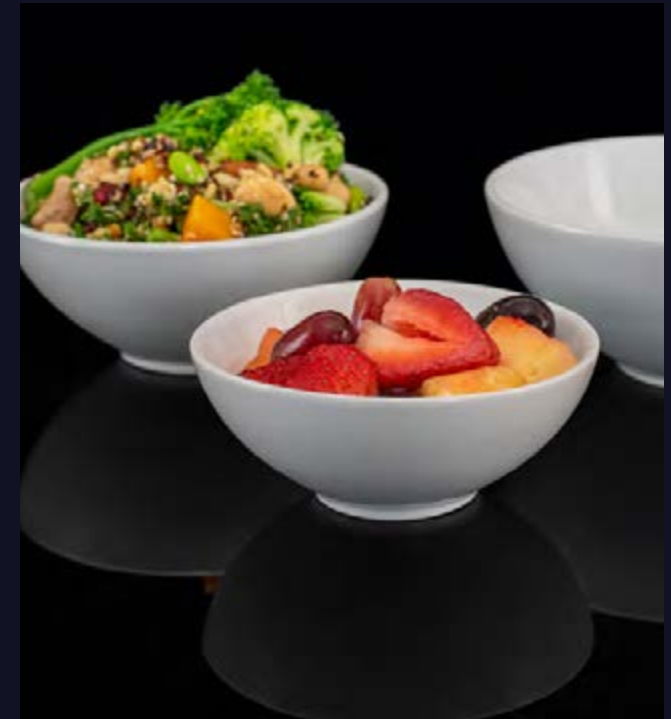

SERVICE ITEMS



01



02



03



04



05



06



07



08



09



Accessories

01	BH603	Sauce Boat 7oz, 20cl	Case Qty 6	04	BH588	Sugar Bowl 9oz, 25cl	Case Qty 12	07	BH572	Handled Jug 8oz, 23cl	Case Qty 6
02	BH557	Salt Pot 3", 8cm	Case Qty 12	05	BH576	Teapot 32oz, 92cl	Case Qty 4	07	BH571	Handled Jug 5oz, 14cl	Case Qty 6
02	BH556	Pepper Pot 3", 8cm	Case Qty 12	05	BH575	Teapot 16oz, 46cl	Case Qty 4	08	BH596	Unhandled Jug 1 3/4oz, 5cl	Case Qty 12
03	BH595	Small Sauce Dish 3 1/2oz, 8cm	Case Qty 12	06	BJ333	Lid for BH575 Teapot	Case Qty 6	09	BH471	Butter Pad 6.5cm dia x 3.5cm	Case Qty 12

BUFFET

Superwhite Buffet Platter

- Stacking platter
- Ideal for sharing platter



Oblong Platter

BH597 54 x 21 x 3.5cm Case Qty 1



Miniature Bowl

BH592 Deep Bowl Shaped Cup 4 $\frac{3}{8}$ " , 11cm, 14oz, 40cl Case Qty 12



Oriental Tableware

- 01 BH527WH Sauce Dish 2 $\frac{3}{4}$ " , 7cm Case Qty 6
- 02 BG489 Chopsticks, Plastic, Pck10, 27cm Case Qty 10



01



02



Superwhite Oven To Tableware

Enhancing the Superwhite Collection, our Plain White Oven to Tableware comprises a durable range of traditional shapes suitable for serving both the Superwhite or modern mezze and tapas dishes.



01



02

Handled Dishes

- 01 **BI050** Lasagne Dish 19.7 x 10.5 x 5.3(h)cm Case Qty 4
 02 **BH444** Mini Square Dish, 12.5 x 12.5 x 4cm Case Qty 6



03

04

Round Pie Bowls

- 03 **BH494** Round Pie Bowl 12 dia x 4(h)cm Case Qty 6
 04 **BH495** Round Pie Bowl 13.5 dia x 4.5(h)cm Case Qty 6



06

05

07

Stacking Ramekins

- 05 **BH604** 2½", 6.5cm, 2½oz, 6.5cl Case Qty 12
 06 **BH605** 3", 7.5cm, 4oz, 11.5cl Case Qty 12
 07 **BH606** 3½", 9cm, 6½oz, 18.5cl Case Qty 12



09

08

Oval Pie Dishes

- 08 **BH618** 6", 15.5cm, 13oz, 36cl Case Qty 6
 09 **BH619** 7", 17.5cm, 13oz, 36cl (Lipped) Case Qty 6



11

10

12

Round Eared Dishes

- 10 **BH607** 5¼", 13cm, 6½oz, 18.5cl Case Qty 6
 11 **BH608** 6", 15cm, 9oz, 25.5cl Case Qty 6
 12 **BH609** 7", 18cm, 17oz, 49.5cl Case Qty 6



13

14

15

16

Oval Eared Dishes

- 13 **BH611** 6½", 16.5cm, 5oz, 13.5cl Case Qty 6
 14 **BH612** 8¾", 22cm, 10oz, 29.5cl Case Qty 6
 15 **BH613** 10", 25cm, 17oz, 49.5cl Case Qty 6
 16 **BH614** 11", 28cm, 22oz, 63cl Case Qty 6



ARTISAN



CONTENTS

ARTISAN NEUVELL

Glossy, matt and satin colour glazes on a high quality, fully vitrified stoneware body

Tempest	19
Heligan	22
Lagoon	25
Kernow	28
Andromeda	30
Serene	32
Shore	34
Armeria	36
Cove	37
Coal	38
Elm	39
Trevone	40

ARTISAN CLASSIC

Texture and colour on a vitrified high alumina porcelain body

Pebble	41
Coast	44
Granite	46
Crème	47
Onyx	49
Product Care	50

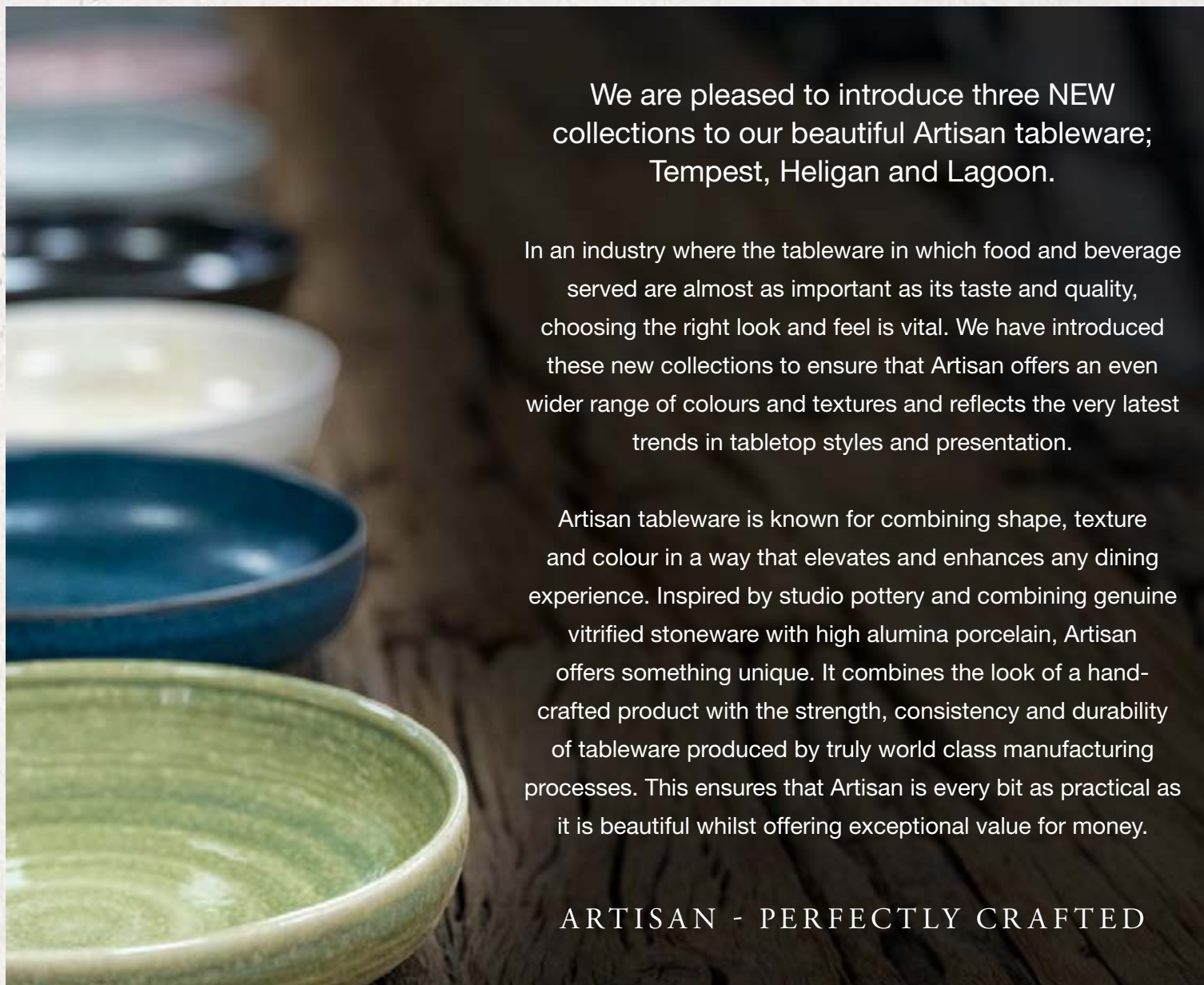

We are pleased to introduce three NEW collections to our beautiful Artisan tableware; Tempest, Heligan and Lagoon.

In an industry where the tableware in which food and beverage served are almost as important as its taste and quality, choosing the right look and feel is vital. We have introduced these new collections to ensure that Artisan offers an even wider range of colours and textures and reflects the very latest trends in tabletop styles and presentation.

Artisan tableware is known for combining shape, texture and colour in a way that elevates and enhances any dining experience. Inspired by studio pottery and combining genuine vitrified stoneware with high alumina porcelain, Artisan offers something unique. It combines the look of a hand-crafted product with the strength, consistency and durability of tableware produced by truly world class manufacturing processes. This ensures that Artisan is every bit as practical as it is beautiful whilst offering exceptional value for money.

ARTISAN - PERFECTLY CRAFTED

TEMPEST COLLECTION

TEMPEST COLLECTION

Tempest combines our new innovative flatware shape and multifunctional bowls with the deep beauty of the Tempest glaze; an inky blue reactive glaze that is semi-matt dotted with gloss and a deep russet brown edge. Contrast is vital in creating the perfect plating, Tempest delivers contrast with style.

NEW



TEMPEST COLLECTION



PLATES

01	BQ917	Dinner Plate 10 $\frac{1}{8}$ " , 26cm	Case Qty 4
01	BQ918	Salad Plate 8 $\frac{3}{8}$ " , 22cm	Case Qty 6
01	BQ919	Side Plate 6 $\frac{1}{8}$ " , 16cm	Case Qty 6

BOWLS

02	BQ923	Bowl 9" , 23cm	Case Qty 4
02	BQ922	Bowl 7 $\frac{1}{2}$ " , 20cm	Case Qty 4
03	BQ921	Bowl 5 $\frac{9}{16}$ " , 15cm	Case Qty 6
03	BQ920	Bowl 4 $\frac{3}{4}$ " , 12cm	Case Qty 6
04	BQ930	Dip Bowl 2.5oz	Case Qty 6
05	BQ931	Buffet Bowl 11" , 28cm	Case Qty 1

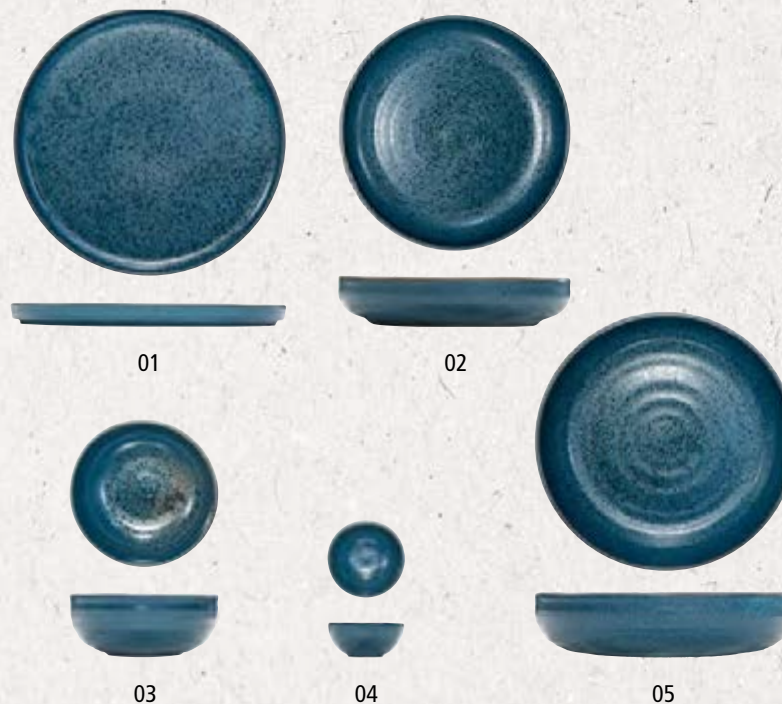

TEMPEST COLLECTION



06



07



08



09

PLATTERS

- | | | | |
|----|--------------|---------------------------|------------|
| 06 | BQ929 | Oval Platter 12", 30cm | Case Qty 4 |
| 06 | BQ928 | Oval Platter 9 1/2", 25cm | Case Qty 4 |

BEVERAGE

- | | | | |
|----|--------------|--------------------|------------|
| 07 | BQ924 | Mug 12oz, 34cl | Case Qty 4 |
| 08 | BQ925 | Jug 5oz, 14.7cl | Case Qty 6 |
| 08 | BQ926 | Jug 2.5oz, 7.4cl | Case Qty 6 |
| 09 | BQ927 | Tea Pot 18oz, 53cl | Case Qty 4 |



HELIGAN COLLECTION

HELIGAN COLLECTION

A meadow green glaze that reacts during firing to produce highlights of lilacs and turquoise, the Heligan collection brings nature to the table. Perfectly suited for the local pub, busy restaurant or fine dining, the durability of fully vitrified stoneware combined with innovation in shape, texture and colour is perfect for any dish.



HELIGAN COLLECTION

PLATES

01	BQ932	Dinner Plate 10 $\frac{1}{2}$ " , 26cm	Case Qty 4
01	BQ933	Salad Plate 8 $\frac{3}{5}$ " , 22cm	Case Qty 6
01	BQ934	Side Plate 6 $\frac{1}{3}$ " , 16cm	Case Qty 6

BOWLS

02	BQ938	Bowl 9" , 23cm	Case Qty 4
02	BQ937	Bowl 7 $\frac{9}{10}$ " , 20cm	Case Qty 4
03	BQ936	Bowl 5 $\frac{9}{10}$ " , 15cm	Case Qty 6
03	BQ935	Bowl 4 $\frac{3}{4}$ " , 12cm	Case Qty 6
04	BQ945	Dip Bowl 2.5oz	Case Qty 6
05	BQ946	Buffet Bowl 11" , 28cm	Case Qty 1

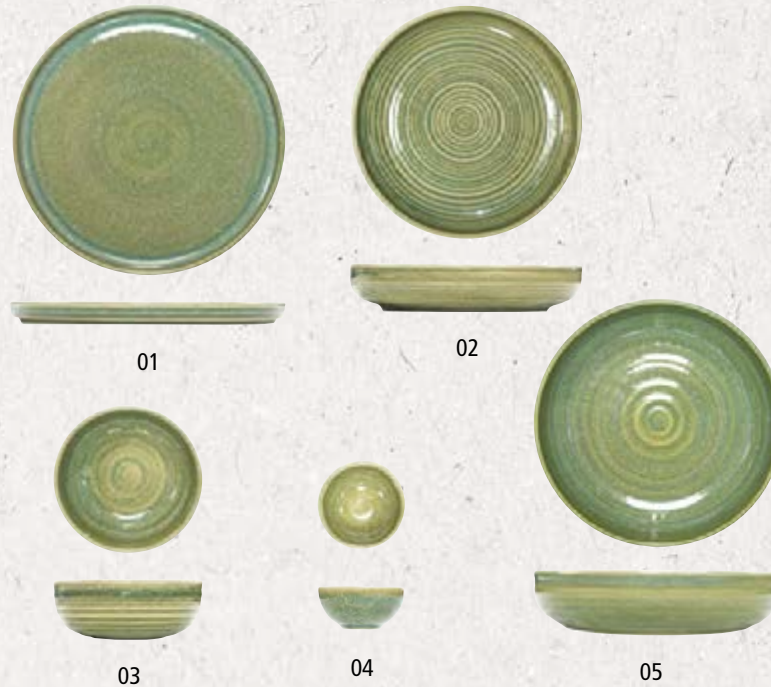

HELIGAN COLLECTION



06



07



08



09

BEVERAGE

06	BQ939	Mug 12oz, 34cl	Case Qty 4
07	BQ940	Jug 5oz, 14.7cl	Case Qty 6
07	BQ941	Jug 2.5oz, 7.4cl	Case Qty 6
08	BQ942	Tea Pot 18oz, 53cl	Case Qty 4

PLATTERS

09	BQ944	Oval Platter 11 $\frac{1}{2}$ ", 30cm	Case Qty 4
09	BQ943	Oval Platter 9 $\frac{1}{2}$ ", 25cm	Case Qty 4

LAGOON COLLECTION

LAGOON COLLECTION

Using our Artisan classic shapes and the ultra-durable high alumina vitrified porcelain body, Artisan Lagoon is our most dramatic look yet. With each unique piece delivering high gloss colours varying from Ochre sandy tones to shimmering blue, which we contrast with a semi-matt neutral exterior – the result is a beautiful, crafted look perfect for food in any setting.

NEW



LAGOON COLLECTION



PLATES

01	BQ949	Coupe Plate 11 1/2", 30cm	Case Qty 6
01	BQ950	Coupe Plate 10 3/8", 27cm	Case Qty 6
01	BQ951	Coupe Plate 6 7/8", 17cm	Case Qty 12
02	BQ963	Flat Plate 8 1/4", 21cm	Case Qty ??

BOWLS

03	BQ952	Deep Coupe Bowl 9 1/2", 25cm	Case Qty 6
04	BQ954	Stacking Tapas Bowl 5 1/2", 14cm	Case Qty 4
04	BQ953	Stacking Tapas Bowl 4 2/3", 12cm	Case Qty 6
05	BQ957	Side Bowl 6", 16cm	Case Qty 4
05	BQ956	Side Bowl 5 1/2", 14cm	Case Qty 4
06	BQ955	Stacking Conical Bowl 4 1/3", 11cm	Case Qty 6
07	BQ964	Dip Pot 2 3/4", 7cm	Case Qty 12
08	BQ959	Globe Dip Pot 2.5oz, 7cl	Case Qty 12
09	BQ958	Globe Mini Jug 2.5oz, 7cl	Case Qty 12

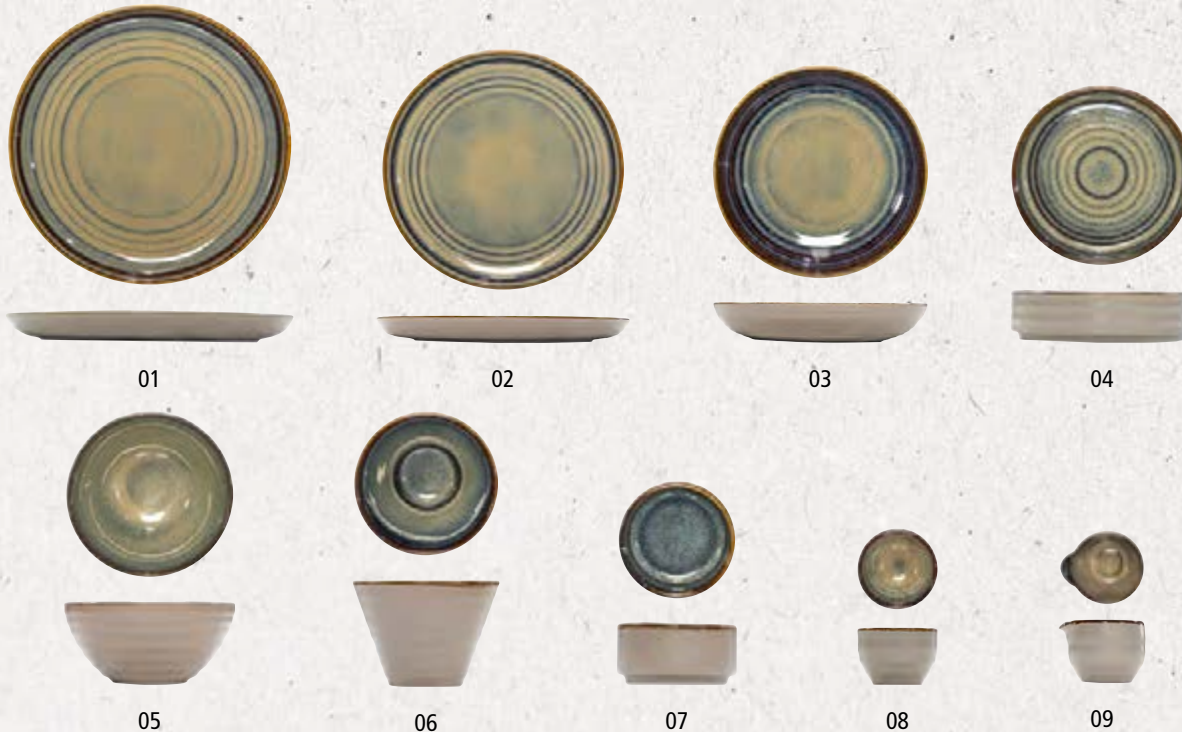

LAGOON COLLECTION



BEVERAGE

10	BQ961	Cappuccino Cup 10oz, 30cl	Case Qty 6
11	BQ960	Tea Cup 7oz, 20cl	Case Qty 12
12	BQ962	"All For One" Saucer 6", 15cm	Case Qty 12

Saucer Compatibility Guide
BQ962 Fits BQ960 & BQ961



10



11



12



KERNOW COLLECTION

KERNOW COLLECTION

Granite speckled and satin finished, the Kernow collection uses a reactive grey glaze to ensure a hand crafted feel with every piece being unique.

Grey has become the colour of choice to present stunning looking dishes.

Add the crafted look with the Kernow reactive speckle together with a collection of fine coupe shapes your stage is set.

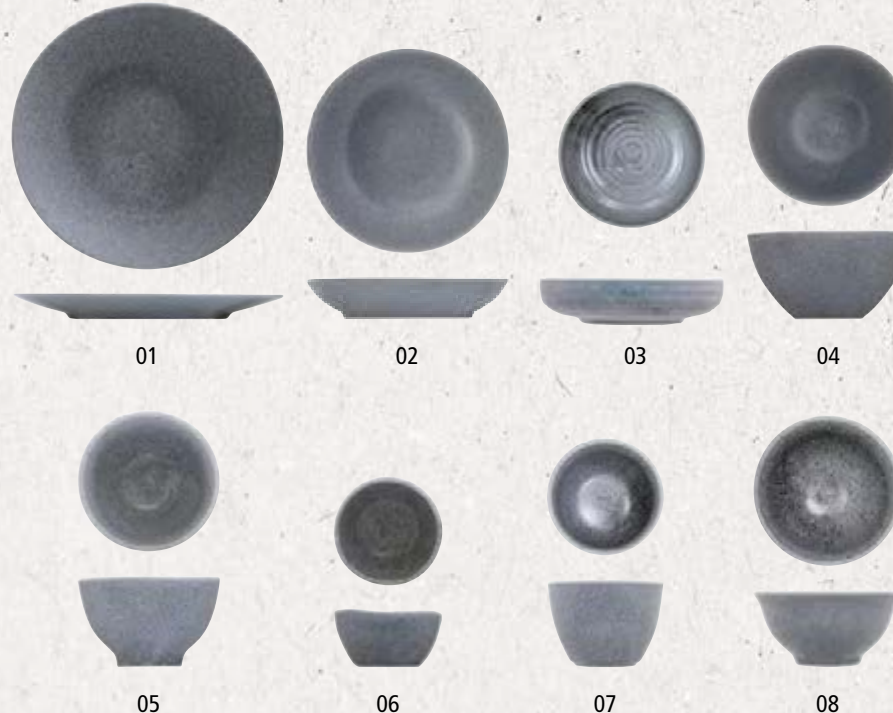
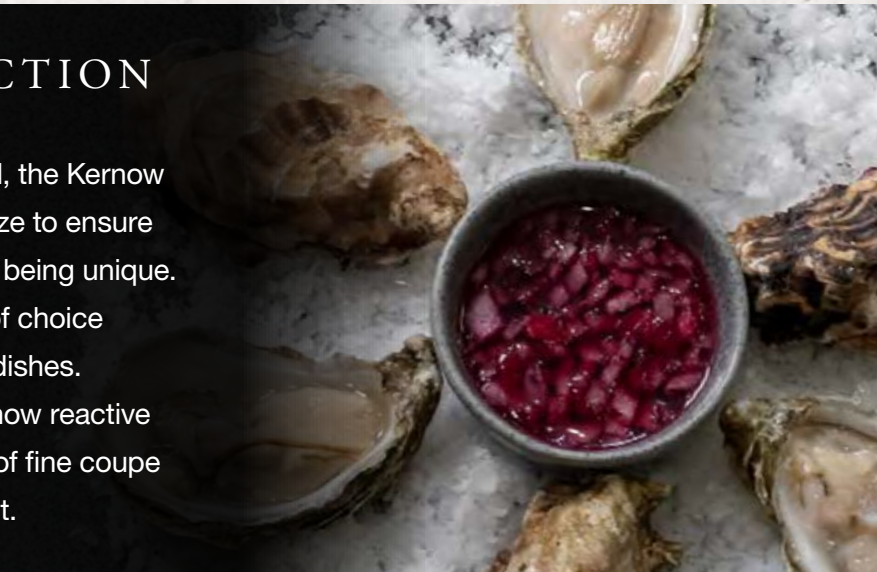

PLATES

01	BL125	Coupe Plate 12 $\frac{3}{8}$ " , 32cm	Case Qty 3
01	BL126	Coupe Plate 10 $\frac{3}{8}$ " , 27.5cm	Case Qty 4
01	BL127	Coupe Plate 8 $\frac{1}{4}$ " , 21cm	Case Qty 6
01	BL131	Coupe Plate 6 $\frac{1}{8}$ " , 16cm	Case Qty 6

BOWLS

02	BL133	Coupe Bowl 9" , 23cm	Case Qty 4
02	BL129	Coupe Bowl 7 $\frac{1}{2}$ " , 19cm	Case Qty 6
03	BQ422	Low Bowl, 20cm, 70cl	Case Qty 6
04	BL128	Deep Bowl 6 $\frac{1}{8}$ " , 15.5cm	Case Qty 6
05	BL134	Mini Bowl 4" , 10cm	Case Qty 6
06	BL132	Dip Pot 2" , 7cm	Case Qty 24
07	BM562	Chip Pot 14oz, 41.5cl	Case Qty 6
08	BM566	Side Bowl 5 $\frac{1}{8}$ " , 13.5cm	Case Qty 6



KERNOW COLLECTION

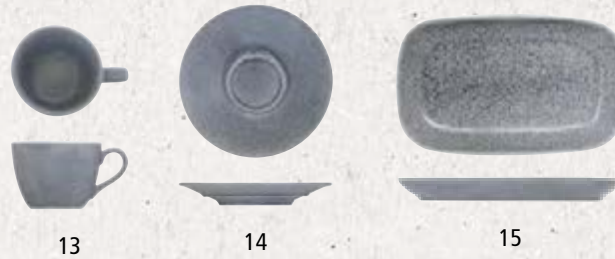

BEVERAGE

09	BL130	Mug 12oz, 34cl	Case Qty 6
10	BL137	Cappuccino Cup 10oz, 30cl	Case Qty 6
11	BP809	Espresso Cup, 3oz	Case Qty 6
12	BP810	Espresso Saucer, 11.5cm	Case Qty 6
13	BL135	Tea Cup 7oz, 20cl	Case Qty 6
14	BL136	"All For One" Saucer 6", 15cm	Case Qty 6

PLATTERS

15	BM570	Rectangular Platter 12 $\frac{1}{8}$ ", 31cm	Case Qty 4
15	BM572	Rectangular Platter 10 $\frac{5}{8}$ ", 27.6cm	Case Qty 6
15	BM574	Rectangular Platter 9 $\frac{3}{4}$ ", 24.7cm	Case Qty 6



Saucer Compatibility Guide BL136 Fits BL130, BL135 & BL137

ANDROMEDA COLLECTION

ANDROMEDA COLLECTION

The endless Cornish night skies inspired the use of the Andromeda reactive glaze. A semi matt shimmering black glaze, which subtly varies with shades of petrol blue and granite flecks.

Combining a glaze that gives wonderful contrast to your food with fine coupe shapes opens up a world of dramatic food presentation.

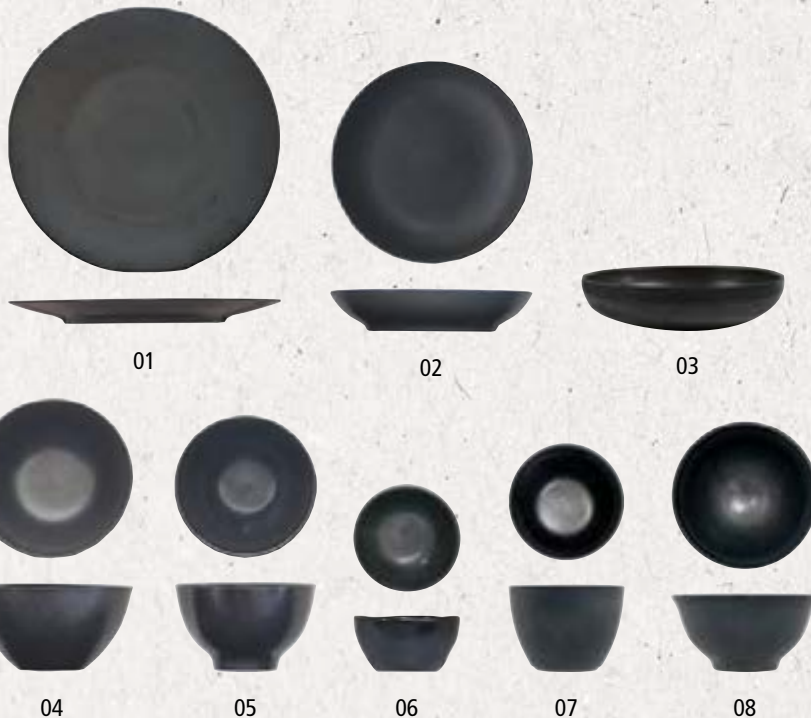

PLATES

01	BL099	Coupe Plate 12 ³ / ₈ " , 32cm	Case Qty 3
01	BL100	Coupe Plate 10 ³ / ₈ " , 27.5cm	Case Qty 4
01	BL101	Coupe Plate 8 ¹ / ₄ " , 21cm	Case Qty 6
01	BL105	Coupe Plate 6 ¹ / ₈ " , 16cm	Case Qty 6

BOWLS

02	BL107	Coupe Bowl 9" , 23cm	Case Qty 4
02	BL103	Coupe Bowl 7 ¹ / ₂ " , 19cm	Case Qty 6
03	BQ423	Low Bowl, 20cm, 70cl	Case Qty 6
04	BL102	Deep Bowl 6 ¹ / ₈ " , 15.5cm	Case Qty 6
05	BL108	Mini Bowl 4" , 10cm	Case Qty 6
06	BL106	Dip Pot 2" , 7cm	Case Qty 24
07	BM561	Chip Pot 14oz, 41.5cl	Case Qty 6
08	BM565	Side Bowl 5 ¹ / ₈ " , 13.5cm	Case Qty 6



ANDROMEDA COLLECTION



BEVERAGE

09	BL104	Mug 12oz, 34cl	Case Qty 6
10	BL111	Cappuccino Cup 10oz, 30cl	Case Qty 6
11	BM946	Espresso Cup 3oz 9cl	Case Qty 6
12	BL109	Tea Cup 7oz, 20cl	Case Qty 6
13	BL110	"All For One" Saucer 6", 15cm	Case Qty 6
14	BM947	Espresso Saucer 11cm	Case Qty 6



09



10



11



12



13



14

PLATTERS

15	BM569	Rectangular Platter 12 $\frac{1}{2}$ ", 31cm	Case Qty 4
15	BM571	Rectangular Platter 10 $\frac{5}{8}$ ", 27.6cm	Case Qty 6
15	BM573	Rectangular Platter 9 $\frac{3}{4}$ ", 24.7cm	Case Qty 6



15



Saucer Compatibility Guide
 BL110 Fits BL104, BL109 & BL111
 BM947 Fits BM946

SERENE COLLECTION

SERENE COLLECTION

With a natural and calm tone, the Serene collection of genuine vitrified stoneware from Artisan captures the essence of rustic tableware with more than a hint of elegance. Satin finish glaze in pale sage and with reactive rust flecks, Serene provides a background that compliments rather than fights your presentation.

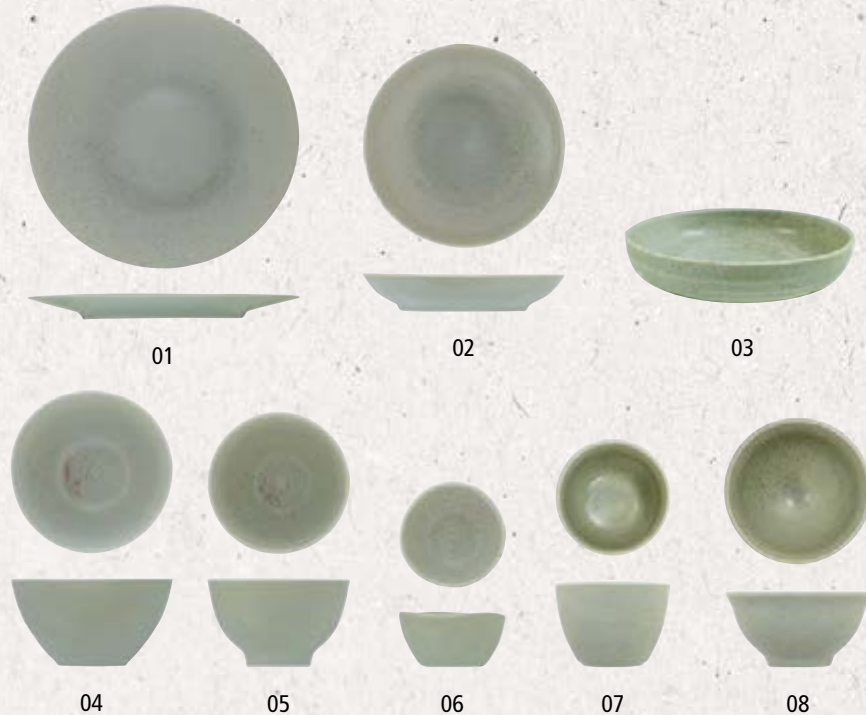

PLATES

01	BL143	Coupe Plate 12 $\frac{3}{8}$ " , 32cm	Case Qty 3
02	BL144	Coupe Plate 10 $\frac{5}{8}$ " , 27.5cm	Case Qty 4
02	BL145	Coupe Plate 8 $\frac{1}{4}$ " , 21cm	Case Qty 6
02	BL149	Coupe Plate 6 $\frac{1}{3}$ " , 16cm	Case Qty 6

BOWLS

02	BL151	Coupe Bowl 9" , 23cm	Case Qty 4
02	BL147	Coupe Bowl 7 $\frac{1}{2}$ " , 19cm	Case Qty 6
03	BQ425	Low Bowl, 20cm, 70cl	Case Qty 6
04	BL146	Deep Bowl 6 $\frac{1}{3}$ " , 15.5cm	Case Qty 6
05	BL152	Mini Bowl 4" , 10cm	Case Qty 6
06	BL150	Dip Pot 2" , 7cm	Case Qty 24
07	BM563	Chip Pot 14oz, 41.5cl	Case Qty 6
08	BM567	Side Bowl 5 $\frac{1}{3}$ " , 13.5cm	Case Qty 6



SERENE COLLECTION



BEVERAGE

09	BL148	Mug 12oz, 34cl	Case Qty 6
10	BL155	Cappuccino Cup 10oz, 30cl	Case Qty 6
11	BL153	Tea Cup 7oz, 20cl	Case Qty 6
12	BL154	"All For One" Saucer 6", 15cm	Case Qty 6



Saucer Compatibility Guide
BL154 Fits BL148,
BL153 & BL155

SHORE COLLECTION

SHORE COLLECTION

The dramatic coastline of Cornwall and miles of sandy beaches gave rise to the Artisan Shore collection. Produced in the highest quality vitrified stoneware, Shore has a satin finished warm cream base colour with a dense mineral reactive speckle. Each piece is unique, and natural variations in the finish ensures it does not feel mass produced.

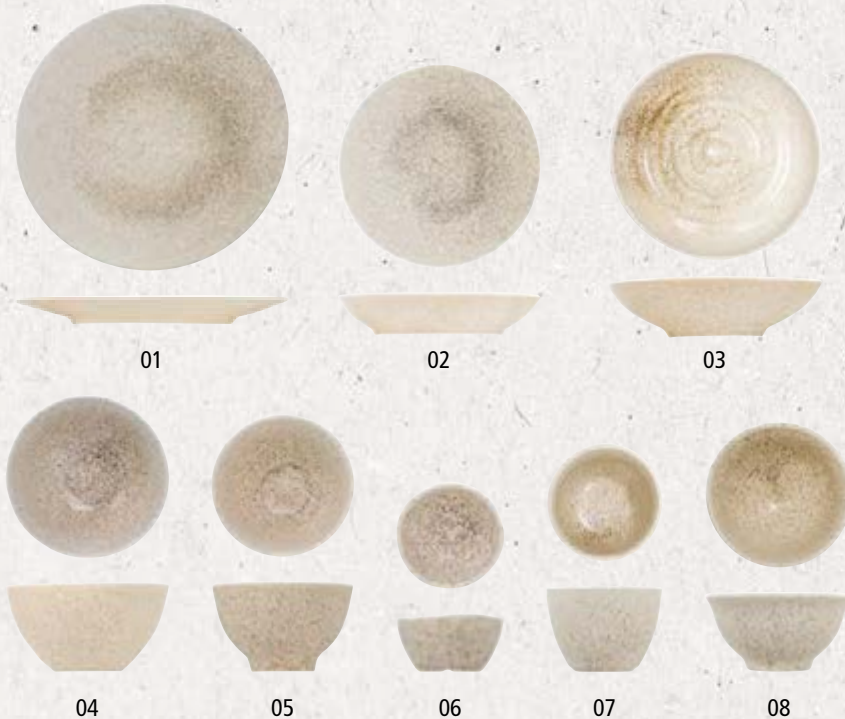

PLATES

01	BL112	Coupe Plate 12 $\frac{3}{8}$ " , 32cm	Case Qty 3
01	BL113	Coupe Plate 10 $\frac{3}{8}$ " , 27.5cm	Case Qty 4
01	BL114	Coupe Plate 8 $\frac{1}{4}$ " , 21cm	Case Qty 6
01	BL118	Coupe Plate 6 $\frac{1}{8}$ " , 16cm	Case Qty 6

BOWLS

02	BL120	Coupe Bowl 9" , 23cm	Case Qty 4
02	BL116	Coupe Bowl 7 $\frac{1}{2}$ " , 19cm	Case Qty 6
03	BQ424	Low Bowl, 20cm, 70cl	Case Qty 6
04	BL115	Deep Bowl 6 $\frac{1}{8}$ " , 15.5cm	Case Qty 6
05	BL121	Mini Bowl 4" , 10cm	Case Qty 6
06	BL119	Dip Pot 2" , 7cm	Case Qty 24
07	BM564	Chip Pot 14oz, 41.5cl	Case Qty 6
08	BM568	Side Bowl 5 $\frac{1}{8}$ " , 13.5cm	Case Qty 6



SHORE COLLECTION



BEVERAGE

09	BL117	Mug 12oz, 34cl	Case Qty 6
10	BL124	Cappuccino Cup 10oz, 30cl	Case Qty 6
11	BL122	Tea Cup 7oz, 20cl	Case Qty 6
12	BL123	"All For One" Saucer 6", 15cm	Case Qty 6

Saucer Compatibility Guide
 BL123 Fits BL117,
 BL122 & BL124



ARMERIA COLLECTION

ARMERIA COLLECTION

A satin finish glaze in warm pink and reactive grey mineral flecks, Armeria provides a subtle pink backdrop that will beautifully enhance the presentation of any dish while still leaving your food to do the shouting.

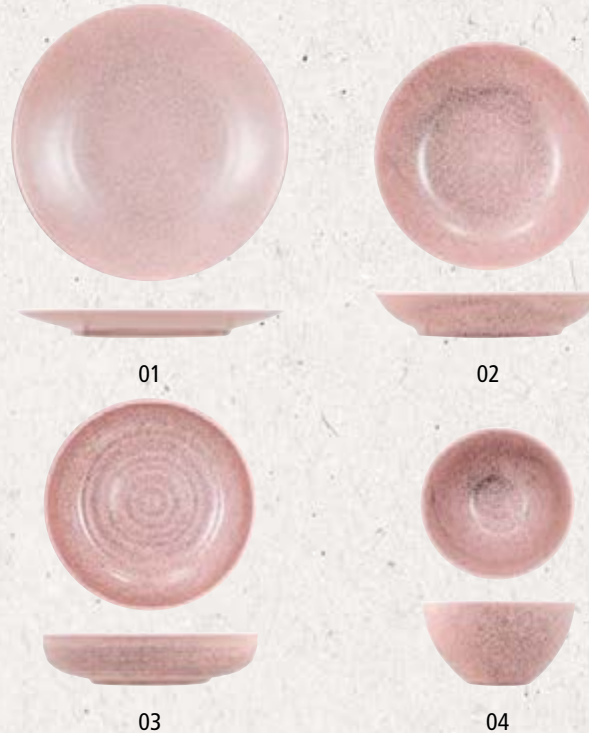
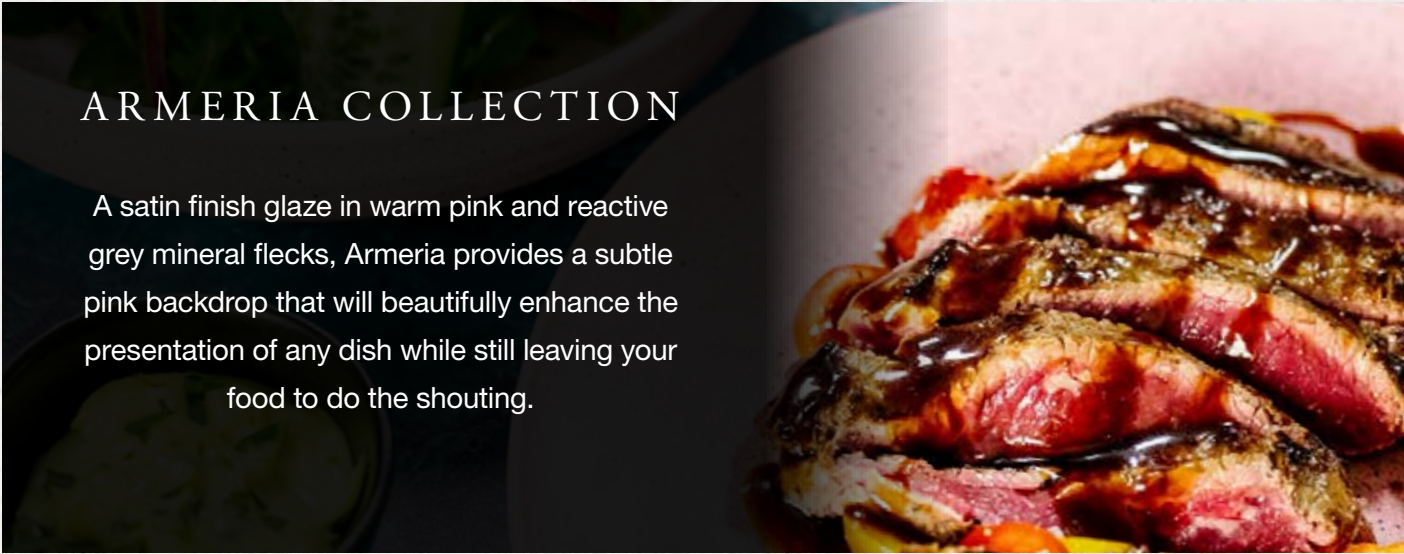

PLATES

01	BQ426	Dinner Plate 10 $\frac{3}{8}$ " , 27.5cm	Case Qty 4
01	BQ427	Coupe Plate 8 $\frac{1}{4}$ " , 21cm	Case Qty 6
01	BQ429	Coupe Plate 6 $\frac{1}{3}$ " , 16cm	Case Qty 6

BOWLS

02	BQ430	Pasta Bowl 9" , 23cm	Case Qty 4
03	BQ421	Low Bowl 7 $\frac{7}{8}$ " , 20cm / 70cl	Case Qty 6
04	BQ428	Deep Bowl 6 $\frac{1}{10}$ " , 15.5cm	Case Qty 6



COVE COLLECTION

STACKING PLATES / BOWL

01	BL199	Stacking Plate 10¼", 26cm	Case Qty 6
02	BL200	Stacking Plate 7½", 20cm	Case Qty 6
03	BL201	Stacking Plate 5", 13cm	Case Qty 6
04	BL202	Stacking Bowl 7½", 20cm	Case Qty 4

ACCESSORIES

05	BL203	Dip Pot 2¼", 7cm	Case Qty 12
06	BL204	Butter Pat 2¼", 7cm	Case Qty 6
07	BL205	Sauce Jug 4.6oz, 13cl	Case Qty 6
08	BL206	Mini Jug 1.75oz, 5cl	Case Qty 6

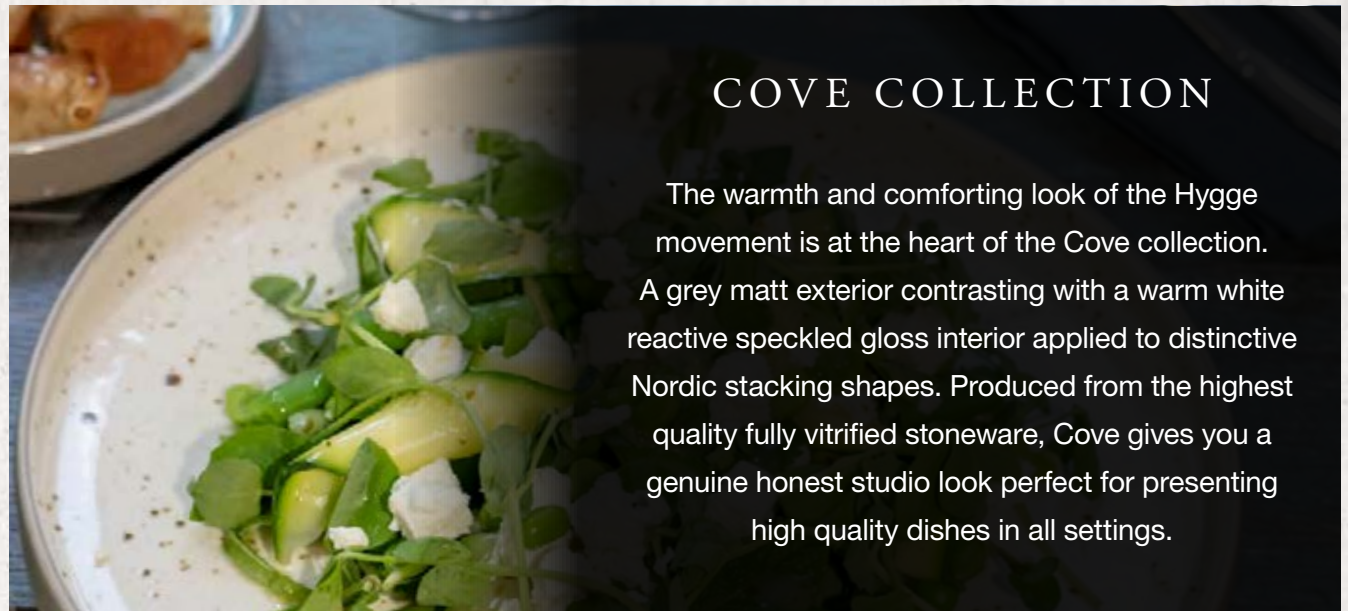

COVE COLLECTION

The warmth and comforting look of the Hygge movement is at the heart of the Cove collection. A grey matt exterior contrasting with a warm white reactive speckled gloss interior applied to distinctive Nordic stacking shapes. Produced from the highest quality fully vitrified stoneware, Cove gives you a genuine honest studio look perfect for presenting high quality dishes in all settings.



01



02



03



04



05



06



07



08



COAL COLLECTION

COAL COLLECTION

The Artisan Coal semi matte black glaze finish provides a striking back drop for your food presentation. The distinctive stacking shape and on-trend Scandinavian style create the perfect canvas.



STACKING PLATES

01	XB709	Stacking Plate 10 $\frac{1}{4}$ " , 26cm	Case Qty 6
02	XB710	Stacking Plate 7 $\frac{1}{2}$ " , 20cm	Case Qty 6
03	BN522	Stacking Plate 5" , 13cm	Case Qty 6



01



02



03

ELM COLLECTION

STACKING PLATES / BOWL

01	BL207	Stacking Plate 10¼", 26cm	Case Qty 6
02	BL208	Stacking Plate 7½", 20cm	Case Qty 6
03	BL209	Stacking Plate 5", 13cm	Case Qty 6
04	BL210	Stacking Bowl 7½", 20cm	Case Qty 4

ACCESSORIES

05	BL211	Dip Pot 2¼", 7cm	Case Qty 12
06	BL212	Butter Pat 2¼", 7cm	Case Qty 6
07	BL213	Sauce Jug 4.6oz, 13cl	Case Qty 6
08	BL214	Mini Jug 1.75oz, 5cl	Case Qty 6



ELM COLLECTION

Genuine stoneware has a unique feel of being hand crafted and artisanal. The Elm collection uses this to great effect, combining a Scandinavian inspired shape with colour and texture. Elm interiors are a rich sage green with a reactive speckle creating variations in every piece. Add the warm grey matt exterior, innovative stacking shapes and you have the perfect modern look.



01



02



03

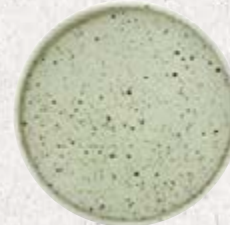

04



05



06



07



08



TREVONE COLLECTION

TREVONE COLLECTION

The hand crafted look of studio ceramics at affordable prices. Trevone uses a reactive and speckled blue glaze that pools and varies naturally on every piece. The contrast of a glossy interior, against the matt exterior, add to the natural feel and look of Trevone.



STACKING PLATES / BOWL

01	BL215	Stacking Plate 10¼", 26cm	Case Qty 6
02	BL216	Stacking Plate 7½", 20cm	Case Qty 6
03	BL217	Stacking Plate 5", 13cm	Case Qty 6
04	BL218	Stacking Bowl 7½", 20cm	Case Qty 4

ACCESSORIES

05	BL219	Dip Pot 2¼", 7cm	Case Qty 12
06	BL220	Butter Pat 2¼", 7cm	Case Qty 6
07	BL221	Sauce Jug 4.6oz, 13cl	Case Qty 6
08	BL222	Mini Jug 1.75oz, 5cl	Case Qty 6



01

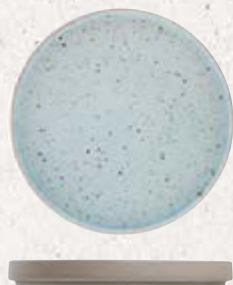

02



03



04



05



06



07



08



PEBBLE COLLECTION

ISLAND PLATES

01	BK525GY	Island Plate 11½", 37cm	Case Qty 3
01	BK526GY	Island Plate 10¾", 33cm	Case Qty 6
01	BK503GY	Island Plate 6¾", 21cm	Case Qty 12
01	BK527GY	Island Deep Plate 6¾", 29cm	Case Qty 3

ISLAND BOWLS

02	BK519GY	Island Bowl 5½", 14cm	Case Qty 8
02	BK517GY	Island Bowl 4¾", 12cm	Case Qty 8

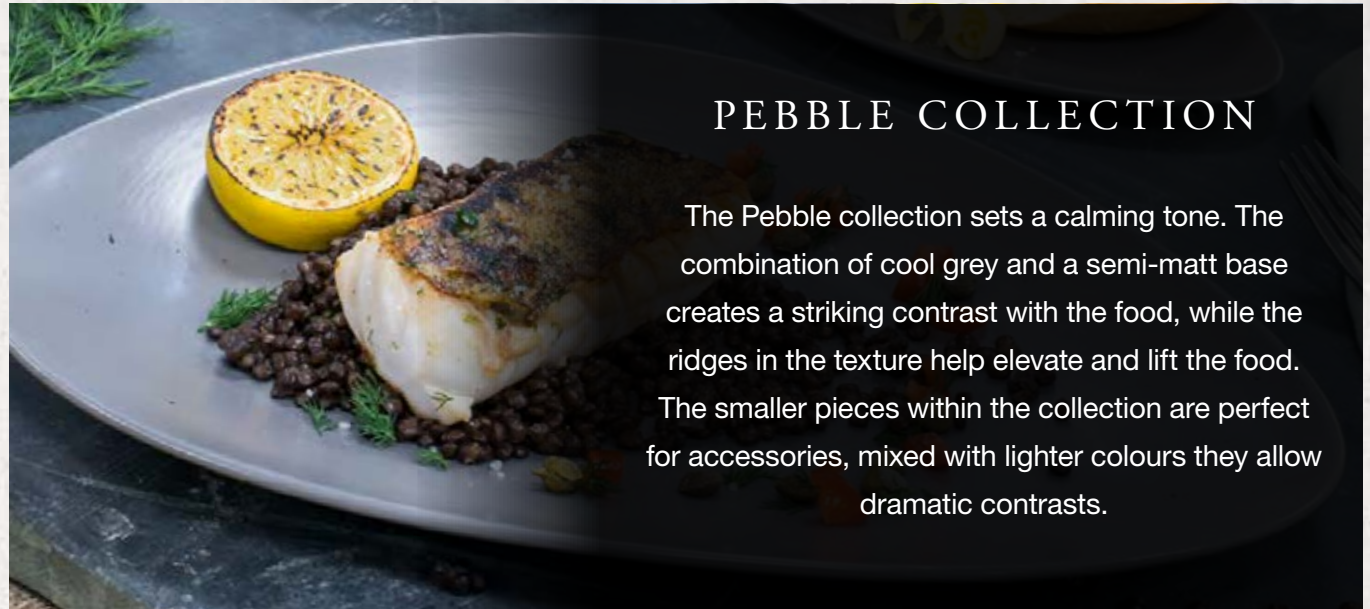

01



02



PEBBLE COLLECTION



03



04



05



06



07



08



09



10



11

PLATES

03	BI846GY	Coupe Plate 11 $\frac{1}{8}$ " , 30cm	Case Qty 6
03	BI847GY	Coupe Plate 10 $\frac{3}{8}$ " , 27cm	Case Qty 6
03	BN500GY	Coupe Plate 8 $\frac{1}{4}$ " , 21cm	Case Qty 12
03	BI848GY	Coupe Plate 6 $\frac{2}{3}$ " , 17cm	Case Qty 12

BOWLS

04	BI849GY	Wide Rim Bowl 11 $\frac{1}{2}$ " , 29cm	Case Qty 6
05	BI850GY	Deep Coupe Bowl 9 $\frac{1}{2}$ " , 25cm	Case Qty 6
06	BI852GY	Stacking Tapas Bowl 5 $\frac{1}{2}$ " , 14cm	Case Qty 4
06	BI851GY	Stacking Tapas Bowl 4 $\frac{2}{3}$ " , 12cm	Case Qty 6
07	BI855GY	Side Bowl 6" , 16cm	Case Qty 4
07	BI854GY	Side Bowl 5 $\frac{1}{2}$ " , 14cm	Case Qty 4
08	BI853GY	Stacking Conical Bowl 4 $\frac{1}{3}$ " , 11cm	Case Qty 6
09	BI858GY	Dip Pot 2 $\frac{3}{4}$ " , 7cm	Case Qty 12
10	BI857GY	Globe Dip Pot 2.5oz, 7cl	Case Qty 12
11	BI856GY	Globe Mini Jug 2.5oz, 7cl	Case Qty 12



PEBBLE COLLECTION

BEVERAGE

12	BI863GY	Grande Cup 16oz, 45cl	Case Qty 6
13	BI862GY	Cappuccino Cup 10oz, 30cl	Case Qty 6
14	BI861GY	Tea Cup 7oz, 20cl	Case Qty 12
15	BI864GY	"All For One" Saucer 6 $\frac{1}{3}$ ", 16cm	Case Qty 12
16	BJ664GY	Espresso Cup 2.5oz, 7cl	Case Qty 12
17	BJ665GY	Espresso Saucer 5 $\frac{1}{8}$ ", 13cm	Case Qty 12
18	BI865GY	Mug 10oz, 28cl	Case Qty 6
19	BJ510GY	Teapot 16oz, 45cl	Case Qty 4



20



12

13

14

15

PLATTERS

20	BI860GY	Rectangular Platter 14 $\frac{1}{2}$ " x 7 $\frac{7}{8}$ " 36 x 20cm	Case Qty 6
20	BI859GY	Rectangular Platter 11 $\frac{1}{2}$ " x 5 $\frac{5}{16}$ " 30 x 15cm	Case Qty 6



16

17

18

19



Saucer Compatibility Guide

BI864GY Fits BI861GY, BI862GY & BI863GY
BJ665GY Fits BJ664GY

COAST COLLECTION

COAST COLLECTION

Radiating rustic charm, Coast is the ideal collection for setting a relaxed mood. Inspired by the finish of hand-crafted studio pottery, Coast creates the perfect background for showcasing natural ingredients. Combining its warm semi-matt background with a natural feel from edge to edge.



PLATES

01	BI847CR	Coupe Plate 10 $\frac{3}{8}$ " , 27.5cm	Case Qty 6
01	BI848CR	Coupe Plate 6 $\frac{1}{3}$ " , 16cm	Case Qty 12

BOWLS

02	BI849CR	Wide Rim Bowl 11 $\frac{3}{8}$ " , 29cm	Case Qty 6
03	BI850CR	Deep Coupe Bowl 9 $\frac{1}{2}$ " , 25cm	Case Qty 6
04	BI852CR	Stacking Tapas Bowl 5 $\frac{1}{2}$ " , 14cm	Case Qty 4
04	BI851CR	Stacking Tapas Bowl 4 $\frac{2}{3}$ " , 12cm	Case Qty 6
05	BI855CR	Side Bowl 6" , 16cm	Case Qty 4
05	BI854CR	Side Bowl 5 $\frac{1}{2}$ " , 14cm	Case Qty 4
06	BI853CR	Stacking Conical Bowl 4 $\frac{1}{3}$ " , 11cm	Case Qty 6
07	BI858CR	Dip Pot 2 $\frac{3}{4}$ " , 7cm	Case Qty 12
08	BI857CR	Globe Dip Pot 2.5oz, 7cl	Case Qty 12
09	BI856CR	Globe Mini Jug 2.5oz, 7cl	Case Qty 12



COAST COLLECTION



BEVERAGE

- | | | |
|----|--------------------------------------------------|-------------|
| 10 | B1862CR Cappuccino Cup 10oz, 30cl | Case Qty 6 |
| 11 | B1861CR Tea Cup 7oz, 20cl | Case Qty 12 |
| 12 | B1864CR "All For One" Saucer 6 1/3", 16cm | Case Qty 12 |
| 13 | B1865CR Mug 10oz, 28cl | Case Qty 4 |



10



11



12



13

PLATTERS

- | | | |
|----|--------------------------------------------------------------------|------------|
| 14 | B1860CR Rectangular Platter
14 1/5" x 7 1/5", 36 x 20cm | Case Qty 6 |
| 14 | B1859CR Rectangular Platter
11 1/5" x 5 1/10", 30 x 15cm | Case Qty 6 |



14



Saucer Compatibility Guide
B1864CR Fits B1861CR, B1862CR

GRANITE COLLECTION

GRANITE COLLECTION

Unique, handmade, broken edge Erosion pieces combined with smooth curves of the Coupe plates and bowls will really bring something special to every table. The glossy reactive glaze and naturally varying shapes will make any presentation look stunning.



01



02



03



04

PLATES

01	BM596	Coupe Plate 11 $\frac{1}{2}$ " , 30cm	Case Qty 6
01	BM597	Coupe Plate 10 $\frac{3}{8}$ " , 27cm	Case Qty 6
01	BM598	Coupe Plate 6 $\frac{3}{8}$ " , 17cm	Case Qty 12

BOWLS

02	BM601	Side Bowl 6 $\frac{1}{2}$ " , 16cm	Case Qty 4
02	BM600	Side Bowl 5 $\frac{1}{2}$ " , 14cm	Case Qty 4
03	BM602	Stacking Conical Bowl 4 $\frac{1}{3}$ " , 11cm	Case Qty 6
04	BM599	Deep Coupe Bowl 9 $\frac{1}{8}$ " , 25cm	Case Qty 6



CRÈME COLLECTION

ISLAND PLATES

01	BK525WH	Island Plate 11½", 37cm	Case Qty 3
01	BK526WH	Island Plate 10¾", 33cm	Case Qty 6
01	BK503WH	Island Plate 6¾", 21cm	Case Qty 12
01	BK527WH	Island Deep Plate 6¾", 29cm	Case Qty 3

ISLAND BOWLS

02	BK519WH	Island Bowl 5½", 14cm	Case Qty 8
02	BK517WH	Island Bowl 4¾", 12cm	Case Qty 8

COUPE PLATES

03	BI846WH	Coupe Plate 11½", 30cm	Case Qty 6
03	BI847WH	Coupe Plate 10¾", 27cm	Case Qty 6
03	BN500WH	Coupe Plate 8¼", 21cm	Case Qty 12
03	BI848WH	Coupe Plate 6¾", 17cm	Case Qty 12

BOWLS

04	BI849WH	Wide Rim Bowl 11½", 29cm	Case Qty 6
05	BI850WH	Deep Coupe Bowl 9¾", 25cm	Case Qty 6
06	BI852WH	Stacking Tapas Bowl 5½", 14cm	Case Qty 4
06	BI851WH	Stacking Tapas Bowl 4¾", 12cm	Case Qty 6
07	BI855WH	Side Bowl 6", 16cm	Case Qty 4
07	BI854WH	Side Bowl 5½", 14cm	Case Qty 4
08	BI853WH	Stacking Conical Bowl 4½", 11cm	Case Qty 6
09	BH795	Dip Pot 2¾", 7cm	Case Qty 12
10	BI857WH	Globe Dip Pot 2.5oz, 7cl	Case Qty 12
11	BI856WH	Globe Mini Jug 2.5oz, 7cl	Case Qty 12



CRÈME COLLECTION

The Crème collection combines perfectly balanced ivory colour with a range of innovative textures, shapes and profiles to create the ideal blank canvas on which chefs can present their art. Designed to be used on it's own or it will also match our existing Crème tableware brand.



CRÈME COLLECTION



PLATTERS

12	BI860WH	Rectangular Platter 14 ¹ / ₅ " x 7 ⁴ / ₅ " 36 x 20cm	Case Qty 6
12	BI859WH	Rectangular Platter 11 ⁴ / ₅ " x 5 ⁹ / ₁₀ " 30 x 15cm	Case Qty 6

BEVERAGE

13	BI863WH	Grande Cup 16oz, 45cl	Case Qty 6
14	BI862WH	Cappuccino Cup 10oz, 30cl	Case Qty 6
15	BI861WH	Tea Cup 7oz, 20cl	Case Qty 12
16	BI864WH	"All For One" Saucer 6 ¹ / ₃ ", 16cm	Case Qty 12
17	BH786	Mug 10oz, 28cl	Case Qty 6
18	BJ510WH	Teapot 16oz, 45cl	Case Qty 4



12



13



14



15



16



17



18



Saucer Compatibility Guide
BI864WH Fits BI861WH, BI862WH, BI863WH

ONYX COLLECTION

PLATES

01	BI846BK	Coupe Plate 11½", 30cm	Case Qty 6
01	BI847BK	Coupe Plate 10¾", 27cm	Case Qty 6
01	BN500BK	Coupe Plate 8¼", 21cm	Case Qty 12
01	BI848BK	Coupe Plate 6¾", 17cm	Case Qty 12

BOWLS

02	BI850BK	Deep Coupe Bowl 9½", 25cm	Case Qty 6
03	BI853BK	Stacking Conical Bowl 4½", 11cm	Case Qty 6
04	BI858BK	Dip Pot 2¾", 7cm	Case Qty 12
05	BI857BK	Globe Dip Pot 2.5oz, 7cl	Case Qty 12



ONYX COLLECTION

The Onyx range uses our ultra durable textured black glaze. At last a black glaze for the catering market that does not scuff or scatch. Not only does Artisan Onyx perform superbly, it looks dramatic and food looks incredible against the dark background.

Mix & match with Creme and Pebble to capture a perfect monochrome theme.



01



02



03



04



05

PRODUCT CARE

STACKING

- Stack items vertically
- Avoid one item sliding or rubbing against another

CHIPPING

The vast majority of Artisan Classic (all plates, bowls, oval dishes, saucers, cups and mugs) are covered by a lifetime edge chip warranty but it's important to follow these basic guidelines:

- Always handle with care – careless or rough handling causes breakages
- Never scrape the product against a bin or receptacle

IN THE DISHWASHER

- Rinse thoroughly after use, before loading into a dishwasher
- Wash separately from other items like glassware, cutlery and cooking equipment
- Follow the dishwasher manufacturer guidelines for type and amount of detergent to use
- Keep the dishwasher fully serviced and clean as per manufacturer guidelines
- If metal marks do appear on Artisan items, clean with a porcelain cleanser. Check cutlery to ensure there no rough edges
- Wash metal surfaces with water & vinegar to remove any particles which could be transferred.



LIFETIME EDGE
CHIP WARRANTY



MICROWAVE SAFE



DISHWASHER SAFE



HEAT RETENTION



THERMAL SHOCK
RESISTANCE



ABRASION &
METAL MARKING
RESISTANCE



STACKABILITY



LEAD AND
CADMIUM FREE

Crème



CONTENTS



CRÈME – SIMPLE, REFINED, BEAUTIFUL.

Crème is the perfect blank canvas for culinary creations – immaculate ivory body colour, classic style and innovative shapes together with truly world-class standards of quality and product performance.... All of this at remarkably affordable prices.

Mix and match the different ranges together to create stunning food presentation.

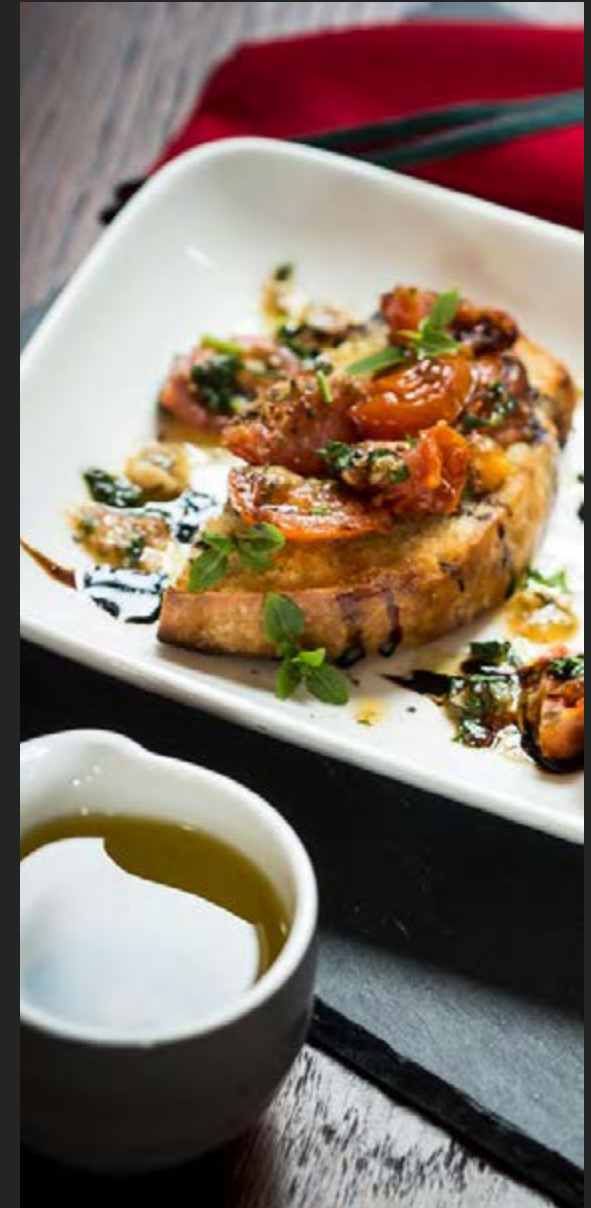

CÉZANNE COLLECTION - WHITE ON WHITE CONCENTRIC BANDS



Plates



01

- 01 **BH803** Rim Plate 12¼", 31cm Case Qty 6
- 01 **BJ799** Rim Plate 11⅜", 29cm Case Qty 6
- 01 **BH802** Rim Plate 10⅞", 27cm Case Qty 12
- 01 **BH801** Rim Plate 10", 25.4cm Case Qty 12
- 01 **BH800** Rim Plate 8¼", 21cm Case Qty 12
- 01 **BH799** Rim Plate 6¾", 17cm Case Qty 12

Bowls & Platter



02



03



04



05



06



07



- 02 **BH806** Rim Bowl 12", 30cm Case Qty 6
- 03 **BH805** Rim Soup Bowl 9", 23cm Case Qty 12
- 04 **BH804** Stacking Soup Unhandled 10oz, 30cl Case Qty 12
- 05 **BI832** Side Bowl 5½", 14cm Case Qty 8
- 06 **BI831** Side Bowl 4¾", 12cm Case Qty 6
- 07 **BI830** Side Bowl 3⅝", 9cm Case Qty 12



08

- 08 **BI833** Oblong Platter 11", 28cm Case Qty 6

CÉZANNE COLLECTION - WHITE ON WHITE CONCENTRIC BANDS

Beverage



09



10



11



12



13



14



15



16



17



18

09 **BH811** Cup 12oz, 34cl Case Qty 12
 10 **BH809** Cup 8oz, 23cl Case Qty 12
 11 **BH810** Cup 3oz, 9cl Case Qty 12
 12 **BH812** Mug 10oz, 28.4cl Case Qty 6
 13 **BH807** Stacking Cup 7oz, 20cl Case Qty 12
 14 **BH808** Stacking Cup 3oz, 9cl Case Qty 12

15 **BH817** Teapot 14oz, 40cl Case Qty 4
 16 **BJ800** Jug 9oz, 25cl Case Qty 12
 16 **BH818** Jug 5oz, 15cl Case Qty 12
 17 **BH814** Large Saucer 6", 15cm Case Qty 12
 18 **BH813** Small Saucer 5", 13cm Case Qty 12



Saucer Compatibility Guide

BH813 Fits BH808, BH810

BH814 Fits BH807, BH809, BH811

MONET COLLECTION - THE MAIN COLLECTION



Plates



01

02

- | | | | |
|----|--------------|---------------------------------------|-------------|
| 01 | BH747 | Rim Plate 12 $\frac{1}{4}$ " , 31cm | Case Qty 6 |
| 01 | BJ483 | Rim Plate 11 $\frac{3}{8}$ " , 29cm | Case Qty 6 |
| 01 | BH746 | Rim Plate 10 $\frac{5}{8}$ " , 27cm | Case Qty 12 |
| 01 | BH745 | Rim Plate 10" , 25.4cm | Case Qty 12 |
| 01 | BH744 | Rim Plate 9" , 23cm | Case Qty 12 |
| 01 | BH743 | Rim Plate 8 $\frac{1}{4}$ " , 21cm | Case Qty 12 |
| 01 | BH721 | Rim Plate 6 $\frac{3}{4}$ " , 17cm | Case Qty 12 |
| 02 | BJ484 | Pizza Plate 12 $\frac{3}{8}$ " , 32cm | Case Qty 6 |

Bowls



03

04

05

06



07

08

09

10

11

12

- | | | | | | | | |
|----|--------------|------------------------------------|-------------|----|--------------|-------------------------------------------|-------------|
| 03 | BH753 | Rim Bowl 12" , 30cm | Case Qty 6 | 09 | BH754 | Side Bowl 3 $\frac{3}{8}$ " , 9cm | Case Qty 12 |
| 04 | BH752 | Rim Bowl 10 $\frac{1}{4}$ " , 26cm | Case Qty 6 | 10 | BH748 | Stacking Soup Handled 10oz, 30cl | Case Qty 8 |
| 05 | BH751 | Rim Soup Bowl 9" , 23cm | Case Qty 12 | 11 | BH749 | Stacking Soup Unhandled 10oz, 30cl | Case Qty 12 |
| 06 | BH750 | Bowl 6 $\frac{1}{4}$ " , 16cm | Case Qty 8 | 12 | BH785 | Soup Bowl Saucer 6 $\frac{3}{4}$ " , 17cm | Case Qty 12 |
| 07 | BH756 | Side Bowl 6 $\frac{1}{4}$ " , 16cm | Case Qty 8 | | | | |
| 08 | BH755 | Side Bowl 4 $\frac{3}{4}$ " , 12cm | Case Qty 12 | | | | |

Saucer Compatibility Guide

BH785 Fits BH748, BH749, BH793, BH804

MONET COLLECTION - THE MAIN COLLECTION

Beverage



13	BH780	Cup 12oz, 34cl	Case Qty 12	20	BH786	Mug 10oz, 28.4cl	Case Qty 6
14	BH781	Cup 8oz, 23cl	Case Qty 12	21	BM579	Mug 8oz, 23cl	Case Qty 6
15	BH782	Cup 3oz, 9cl	Case Qty 12	22	BH787	Stacking Mug 10oz, 28.4cl	Case Qty 12
16	BH959	Traditional Stacking Cup 7oz, 20cl	Case Qty 12	23	BH960	Traditional Saucer 6", 15cm	Case Qty 12
17	BH778	Stacking Cup 7oz, 20cl	Case Qty 12	24	BH783	Saucer Large 6", 15cm	Case Qty 12
18	BH779	Stacking Cup 3oz, 9cl	Case Qty 12	25	BH784	Saucer Small 5", 13cm	Case Qty 12
19	BI828	Mug 12oz, 35cl	Case Qty 6				

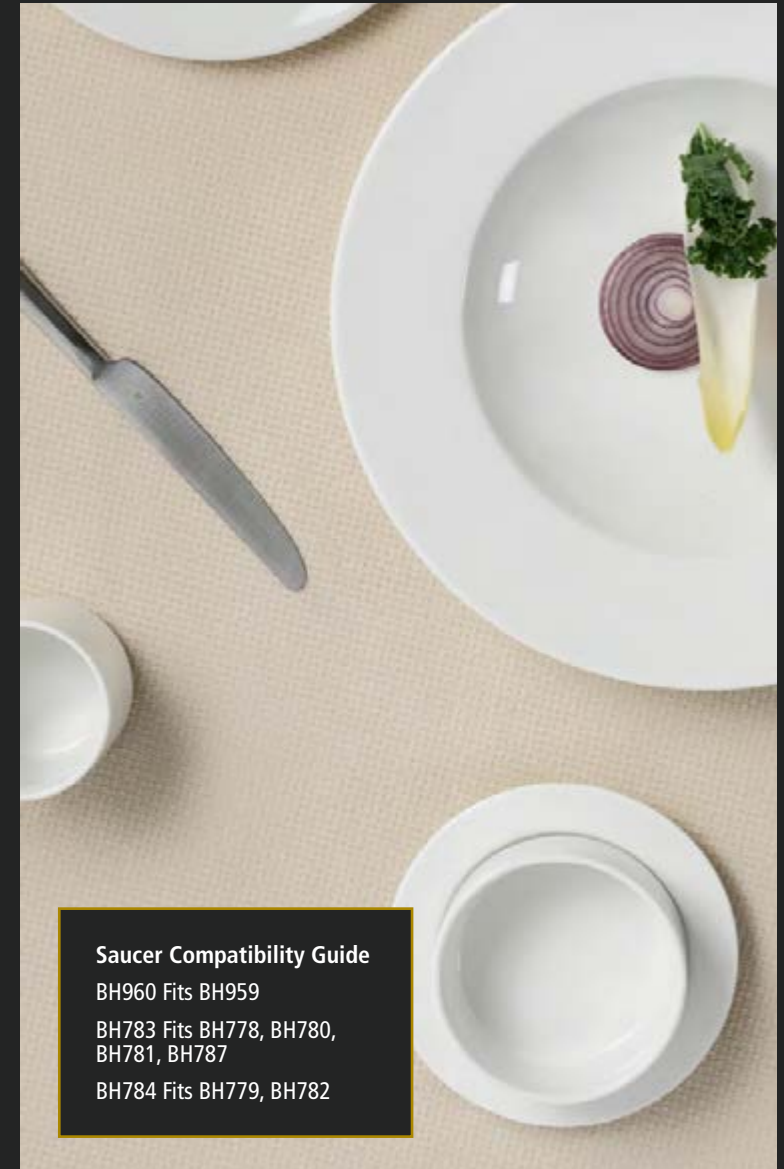

Saucer Compatibility Guide

BH960 Fits BH959

BH783 Fits BH778, BH780,
BH781, BH787

BH784 Fits BH779, BH782

MONET COLLECTION - THE MAIN COLLECTION

Accessories

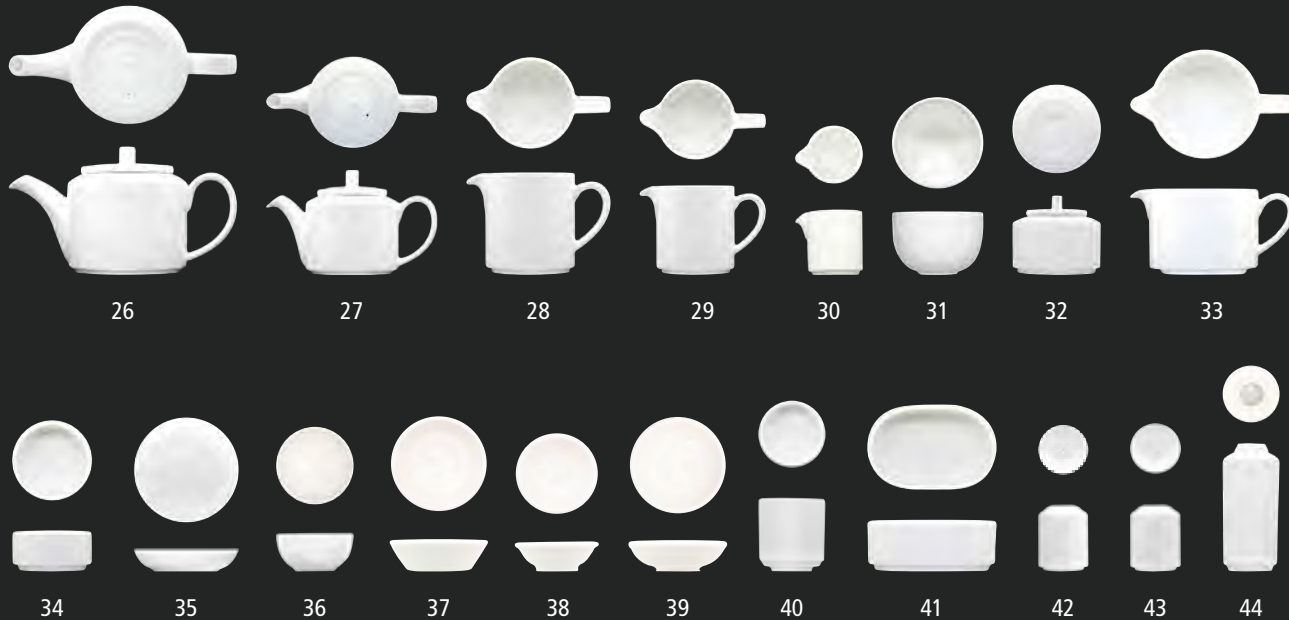

26	BH788	Teapot 28oz, 80cl	Case Qty 1	36	BI504	Dip Bowl 1oz 5.6cm	Case Qty 12
27	BH789	Teapot 14oz, 40cl	Case Qty 4	37	BL859	Conical Sauce Dish 8cm	Case Qty 18
28	BH790	Jug 9oz, 25cl	Case Qty 12	38	BK041	Dip Dish 7.5 x 2.45cm	Case Qty 18
29	BH791	Jug 5oz, 15cl	Case Qty 12	39	BL860	Dip Dish 7cm	Case Qty 18
30	BH792	Jug 2oz, 5cl	Case Qty 12	40	BI637	Egg Cup 5cm	Case Qty 12
31	BJ485	Open Sugar Bowl 8oz, 23cl	Case Qty 12	41	BH798	Sachet Holder 11cm	Case Qty 12
32	BH794	Covered Sugar Bowl 9½oz, 27cl	Case Qty 4	42	BH815	Salt Pot	Case Qty 12
33	BH793	Sauce Boat 12oz, 35cl	Case Qty 6	43	BH816	Pepper Pot	Case Qty 12
34	BH795	Butter Block 7cm	Case Qty 12	44	BI827	Bud Vase	Case Qty 6
35	BH796	Butter Pad 10cm	Case Qty 12				

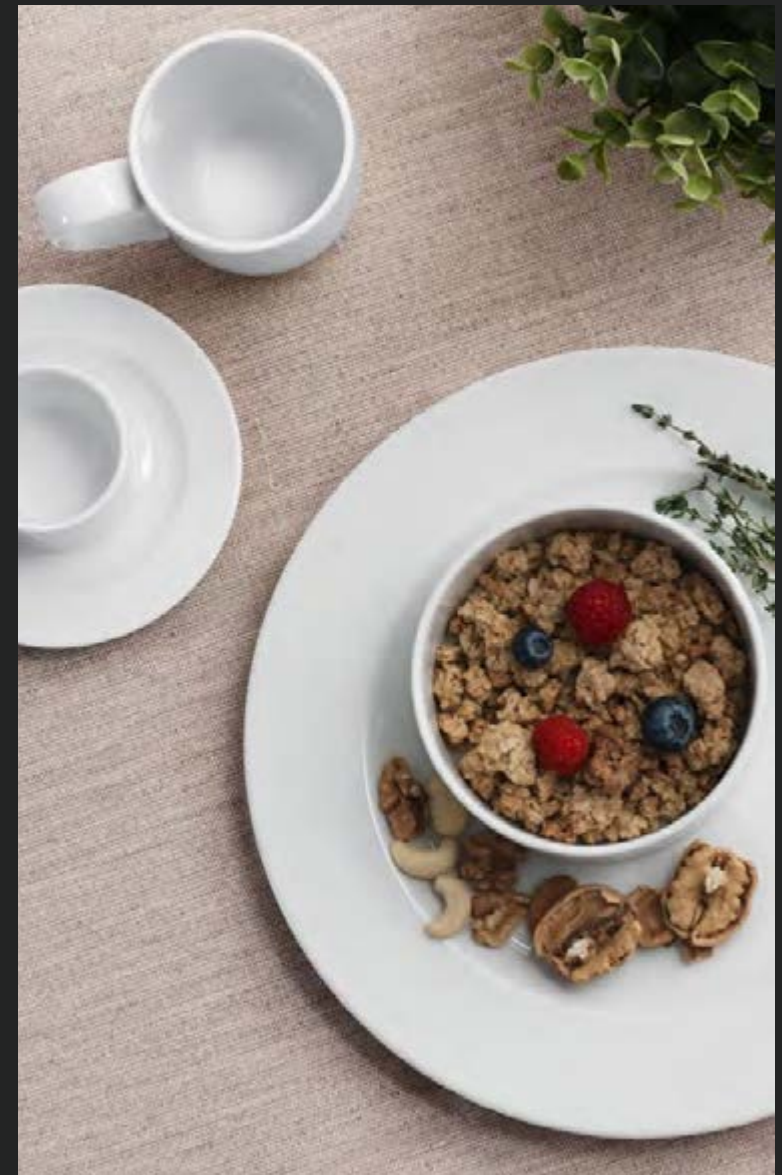

RENOIR COLLECTION - THE COUPE SHAPE



Plates

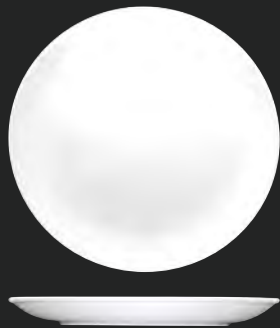

01

01 **BH771** Coupe Plate 12¼", 31cm Case Qty 6

01 **BH770** Coupe Plate 10⅝", 27cm Case Qty 12

01 **BH769** Coupe Plate 9½", 24cm Case Qty 12

01 **BH768** Coupe Plate 8¼", 21cm Case Qty 12

01 **BH767** Coupe Plate 7", 18cm Case Qty 12



02

02 **BH777** Oval Coupe Plate 12½" 32cm Case Qty 6

03 **BH776** Oval Coupe Plate 10¼" 26cm Case Qty 12

04 **BH775** Oval Coupe Plate 8" 20cm Case Qty 12



03



04

Bowls



05

05 **BI829** Deep Coupe Bowl 10¼", 26cm Case Qty 6



06

06 **BH774** Coupe Kick Bowl 8¼", 21cm Case Qty 4



07

07 **BH773** Coupe Kick Bowl 7", 18cm Case Qty 4



08

08 **BH772** Coupe Kick Bowl 4⅔", 12cm Case Qty 8

Platters



09

09 **BH766** Oblong Plate 35.5cm x 16.5cm Case Qty 6



10

10 **BH888** Oblong Plate 28cm x 13.5cm Case Qty 6

RENOIR COLLECTION - THE COUPE SHAPE

Beverage



11

12

13



14

15

16

- | | | | |
|----|----------------|------------------------------|-------------|
| 11 | BM394 | Cup 12oz, 34cl | Case Qty 6 |
| 12 | BM393 | Cup 10oz, 28cl | Case Qty 8 |
| 13 | BM392 | Cup 8oz, 23cl | Case Qty 12 |
| 14 | BM391 | Cup 3oz, 9cl | Case Qty 12 |
| 15 | BM580 | Saucer 5", 13cm | Case Qty 12 |
| 16 | BI864WH | All For One Saucer 6¼", 16cm | Case Qty 12 |



Saucer Compatibility Guide

BI864WH Fits BM394, BM393, BM392

BM580 Fits BM391

ROUSSEAU COLLECTION - EMBOSSED NATURAL WAVES



02



03

Plates



01

Bowls



04



05



06

- 01 **BJ495** Rim Plate 12¼", 31cm Case Qty 6
- 01 **BJ494** Rim Plate 10⅝", 27cm Case Qty 12
- 01 **BJ493** Rim Plate 10", 25.4cm Case Qty 12
- 01 **BJ492** Rim Plate 8¼", 21cm Case Qty 12
- 01 **BJ491** Rim Plate 6¾", 17cm Case Qty 12

- 02 **BJ496** Rim Bowl 12", 30cm Case Qty 6
- 03 **BJ509** Side Bowl 4¾", 12cm Case Qty 6
- 03 **BJ508** Side Bowl 3⅝", 9cm Case Qty 12
- 04 **BJ497** Rim Soup Bowl 9", 23cm Case Qty 12
- 05 **BJ498** Stacking Soup Unhandled 10oz, 30cl Case Qty 12
- 06 **BJ499** Soup Bowl Saucer 6¾", 17cm Case Qty 12

Saucer Compatibility Guide

BJ499 Fits BJ498

ROUSSEAU COLLECTION - EMBOSSED NATURAL WAVES

Beverage



- | | | | |
|----|--------------|-------------------------------|-------------|
| 07 | BJ501 | Cup 8oz, 23cl | Case Qty 12 |
| 08 | BJ500 | Stacking Cup 7oz, 20cl | Case Qty 12 |
| 09 | BJ504 | Mug 10oz, 28.4cl | Case Qty 6 |
| 10 | BJ502 | Saucer Large 6", 15cm | Case Qty 12 |
| 11 | BJ503 | Teapot 14oz, 40cl | Case Qty 4 |
| 12 | BJ507 | Covered Sugar Bowl 9½oz, 27cl | Case Qty 4 |
| 13 | BJ506 | Jug 5oz, 15cl | Case Qty 12 |
| 14 | BJ505 | Jug 2oz, 5cl | Case Qty 12 |



Saucer Compatibility Guide
BJ502 Fits BJ501, BJ500

ESPRIT COLLECTION - ELEGANCE FOR FINE DINE



Gourmet Plates

- 03 **BK510** Gourmet Plate 11", 28cm Case Qty 6
- 04 **BK509** Gourmet Bowl 11", 28cm Case Qty 6



Plates

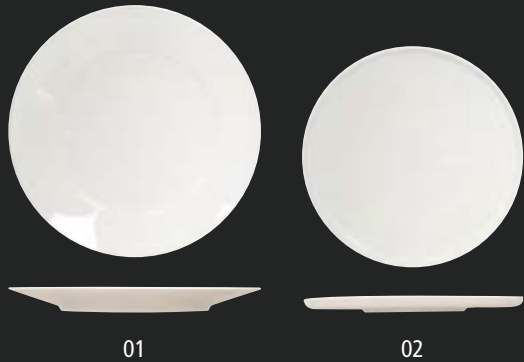

- 01 **BK511** Plate 12¼", 31cm Case Qty 6
- 01 **BK507** Plate 10⅝", 28cm Case Qty 6
- 01 **AR0014** Plate 9⅞", 25cm Case Qty 6
- 01 **BP424** Plate 8⅝", 22cm Case Qty 12
- 01 **BK504** Plate 6⅓", 16cm Case Qty 12
- 02 **BK508** Coupe Plate 8¼", 28cm Case Qty 6

Bowls

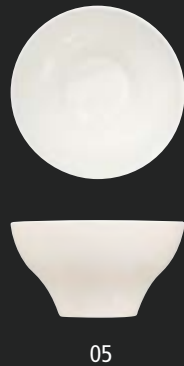

- 05 **BK514** Side Bowl 4¾", 12cm Case Qty 6
- 05 **BK515** Side Bowl 5½", 14cm Case Qty 6



JOUET COLLECTION - STRIKING BOWLS

Jouet Bowls

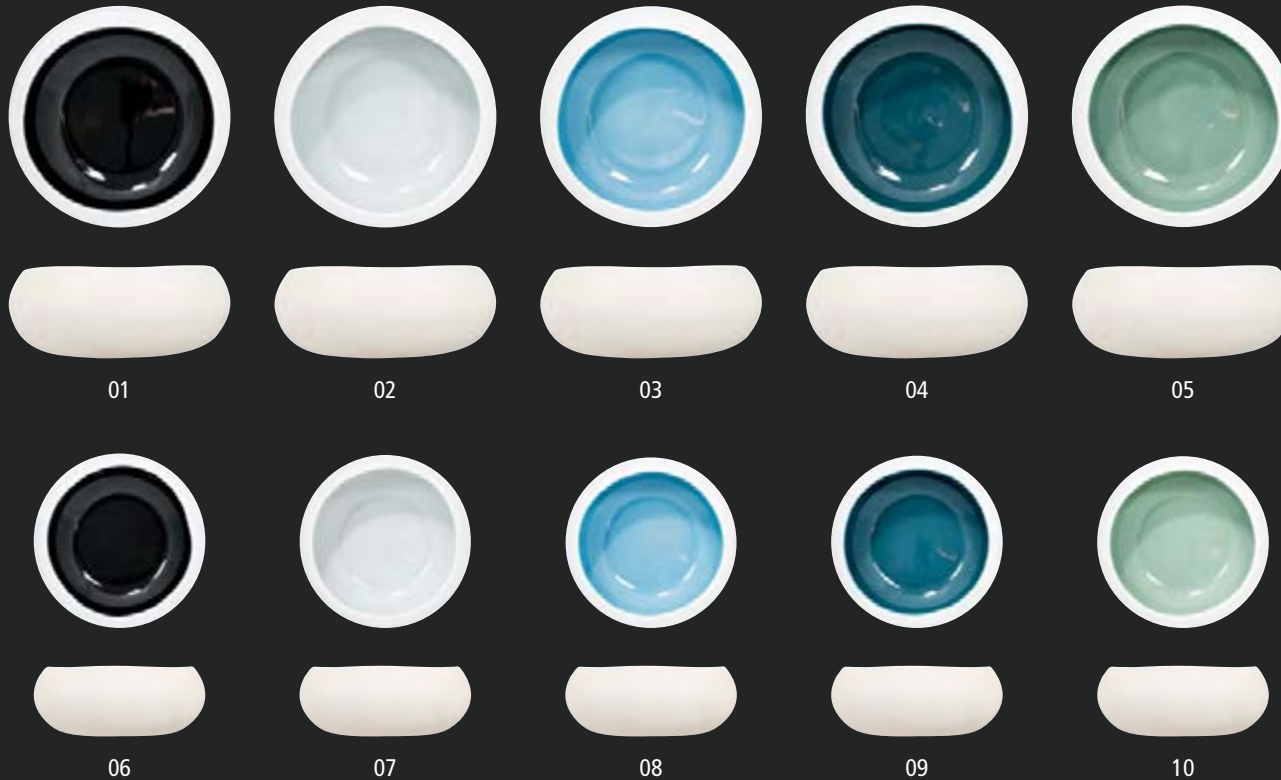

- 01 **BK506BK** Organic Bowl 16cm - Black Case Qty 6
- 02 **BK506GY** Organic Bowl 16cm - Dove Grey Case Qty 6
- 03 **BK506BL** Organic Bowl 16cm - Ash Blue Case Qty 6
- 04 **BK506DG** Organic Bowl 16cm - Sea Green Case Qty 6
- 05 **BK506GN** Organic Bowl 16cm - Pale Sage Case Qty 6

- 06 **BK516BK** Organic Bowl 12cm - Black Case Qty 12
- 07 **BK516GY** Organic Bowl 12cm - Dove Grey Case Qty 12
- 08 **BK516BL** Organic Bowl 12cm - Ash Blue Case Qty 12
- 09 **BK516DG** Organic Bowl 12cm - Sea Green Case Qty 12
- 10 **BK516GN** Organic Bowl 12cm - Pale Sage Case Qty 12



JOUET COLLECTION - CLASSIC MINIS

Jouet Miniatures



01



02



03



04



05

06

07

- 01 **BI835WH** Star Bowl 9 x 4.3cm Case Qty 12
- 02 **BI837WH** Teardrop Bowl 10.7 x 8.4 x 3cm Case Qty 12
- 03 **BI838WH** Conical Bowl 10.7 x 6.3 x 4.4cm Case Qty 12
- 04 **BI839WH** Cube 5.9 x 4.9cm Case Qty 12

- 05 **BI836BK** Curved Bowl 8.5 x 3.5cm Case Qty 12
- 06 **BI837BK** Teardrop Bowl 10.7 x 8.4 x 3cm Case Qty 12
- 07 **BI839BK** Cube 5.9 x 4.9cm Case Qty 12

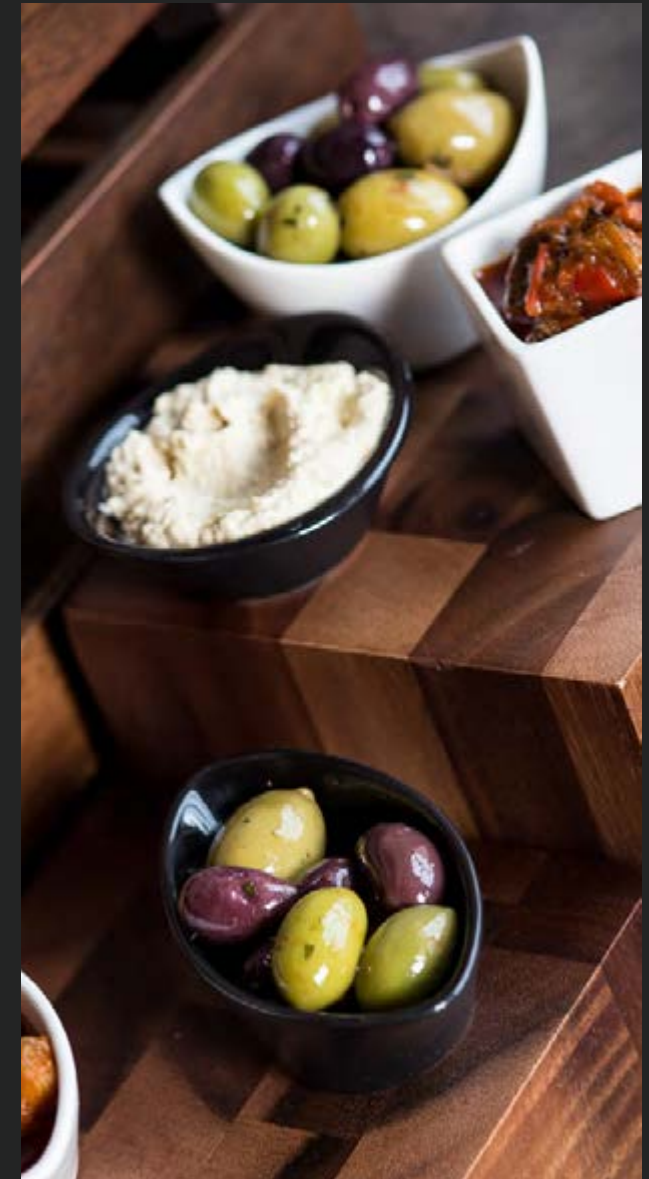

GALERIE COLLECTION - THE BUFFET COLLECTION

Oven To Tableware



01



02



03

- | | | | |
|----|--------------|--------------------------|------------|
| 01 | BM120 | Dish 39 x 25.5 x 6.5cm | Case Qty 2 |
| 02 | BM119 | Dish 25.5 x 25.5 x 6.5cm | Case Qty 2 |
| 03 | BM118 | Dish 25.5 x 13 x 6.5cm | Case Qty 4 |



Buffet Bowls



04



05



06



07



08



09



- | | | | |
|----|----------------|---------------------------------------|------------|
| 04 | BK520WH | Deep Buffet Bowl 23cm - Crème / White | Case Qty 1 |
| 05 | BK520GY | Deep Buffet Bowl 23cm - Pebble / Grey | Case Qty 1 |
| 06 | BK520BK | Deep Buffet Bowl 23cm - Onyx / Black | Case Qty 1 |
| 07 | BK524WH | XL Buffet Bowl 39cm - Crème / White | Case Qty 1 |
| 08 | BK524GY | XL Buffet Bowl 39cm - Pebble / Grey | Case Qty 1 |
| 09 | BK524BK | XL Buffet Bowl 39cm - Onyx / Black | Case Qty 1 |

GALERIE COLLECTION - THE BUFFET COLLECTION

Gastronorm Dishes



01	BI343	GN 1/1 - 53 x 32.5 x 6.5cm	Case Qty 1
02	BI344	GN 1/2 - 32.5 x 26.5 x 6.5cm	Case Qty 1
03	BI345	GN 1/3 - 17.6 x 32.5 x 6.5cm	Case Qty 1
04	BI346	GN 2/3 - 35.4 x 32.5 x 6.5cm	Case Qty 1
05	BI347	GN 2/4 - 53 x 16.2 x 6.5cm	Case Qty 1

Gastronorm Trays



06	BJ490	GN 1/1 - 53 x 32.5 x 2.5cm	Case Qty 1
07	BJ487	GN 1/2 - 32.5 x 26.5 x 2.5cm	Case Qty 1
08	BJ486	GN 1/3 - 17.6 x 32.5 x 2.5cm	Case Qty 1
09	BJ489	GN 2/4 - 53 x 16.2 x 2.5cm	Case Qty 1

Onyx Gastronorm Dishes



10	BK518	GN 1/1 - 53 x 32.5 x 6.5cm	Case Qty 1
11	BK521	GN 1/2 - 32.5 x 26.5 x 6.5cm	Case Qty 1
12	BK522	GN 1/3 - 17.6 x 32.5 x 6.5cm	Case Qty 1
13	BK523	GN 2/4 - 53 x 16.2 x 6.5cm	Case Qty 1

IMPRESSIONS COLLECTION



Cerne

Inspired by the desire to re-imagine the simplest of tableware designs (the round plate) 'Cerne' is the French word for circle. When viewed from above the 'Cerne' shape appears to be entirely conventional but when viewed in profile the radical nature of its design is revealed.



BH892 Cerne Plate 31cm Case Qty 6

Carré

Convention dictates that plates should be round. But like all great artists Crème is happy to defy convention and 'Carré' (which means square in French) demonstrates that there are other ways to perfectly balance form and function when presenting food.



BH890 Carré Plate 27cm x 27cm Case Qty 6

Écharde

Some art reassures, but truly great art is challenging. 'Écharde' took as its inspiration a desire to look at the design of a plate from (quite literally) a number of different angles. Named after the French word for splinter 'Écharde' plays with conventional perspective and ultimately will place a completely different perspective on the food you present.



BH891 Écharde Plate 31cm x 19cm Case Qty 6

Futuriste

Some art looks unashamedly to the future and tries to imagine a different reality. The 'Futuriste' plate is a bold re-imagining of a conventional theme and offers the perfect solution where chefs want to present their own new vision of a classic dish free from the constraints of history.



BH889 Futuriste Plate 34cm x 18cm Case Qty 6

THE QUALITY OF CRÈME

MATERIALS AND MANUFACTURING

- Fully Vitrified, High Alumina Fine Porcelain - Crème is a high alumina content, fully vitrified fine porcelain. Using only the highest grade European materials to formulate the world class ceramic body enables the design and production of fine, elegant shapes whilst maintaining durability and strength.
- Colour - The colour of a plate makes a world of difference to the presentation of the dish. Crème is designed with the most immaculate pale ivory colour as the perfect background to every dish.
- World Class Glaze - Using the most advance glazing processes, the glaze is a class leader for appearance and durability which gives Crème a high resistance to metal marking, scratching and dishwasher attack.
- Face Profiles & Stackability - Designed to stack and manufactured using the latest forming technology, Crème boasts an incredible shape uniformity with perfectly flat centres and sharp definition of shapes meaning no humped centres or whirly bases, and no inconsistent stacking gaps.
- Diamond Polished Foot - Different ceramics have different feet. Crème takes every piece and carefully diamond polishes every foot for a consistently smooth finish.



QUALITY MANAGEMENT

- Exclusively manufactured in a world-class facility that has been awarded ISO9001 for quality management.
- The factory utilises the latest forming, finishing and firing technology to guarantee consistency, efficiency and effective environmental control throughout every process.
- Holding certification for Corporate Social Responsibility to SA8000, the care and well being of the employees & their families is of the utmost importance.
- The factory also holds certification for Environmental Management ISO14000.
- In comparing to the world's best alternative brands, Crème exceeds the very highest standards in the market place. Independent testing results are available upon request.

PRODUCT CARE – HOW TO GET THE BEST FROM YOUR CRÈME TABLEWARE

STACKING

- Stack items vertically
- Avoid one item sliding or rubbing against another

CHIPPING

The vast majority of Crème products (all plates, bowls, oval dishes, saucers, cups and mugs) are covered by a lifetime edge chip warranty but it's important to follow these basic guidelines:

- Always handle with care – careless or rough handling causes breakages
- Never scrape the product against a bin or receptacle

IN THE DISHWASHER

- Rinse thoroughly after use, before loading into a dishwasher
- Wash separately from other items like glassware, cutlery and cooking equipment
- Follow the dishwasher manufacturer guidelines for type and amount of detergent to use
- Keep the dishwasher fully serviced and clean as per manufacturer guidelines
- If metal marks do appear on Crème items, clean with a porcelain cleanser. Check cutlery to ensure there no rough edges
- Wash metal surfaces with water & vinegar to remove any particles which could be transferred.



LIFETIME EDGE
CHIP WARRANTY



MICROWAVE SAFE



DISHWASHER SAFE



HEAT RETENTION



THERMAL SHOCK
RESISTANCE



ABRASION &
METAL MARKING
RESISTANCE



STACKABILITY



LEAD AND
CADMIUM FREE

ARIANE - TABLEWARE

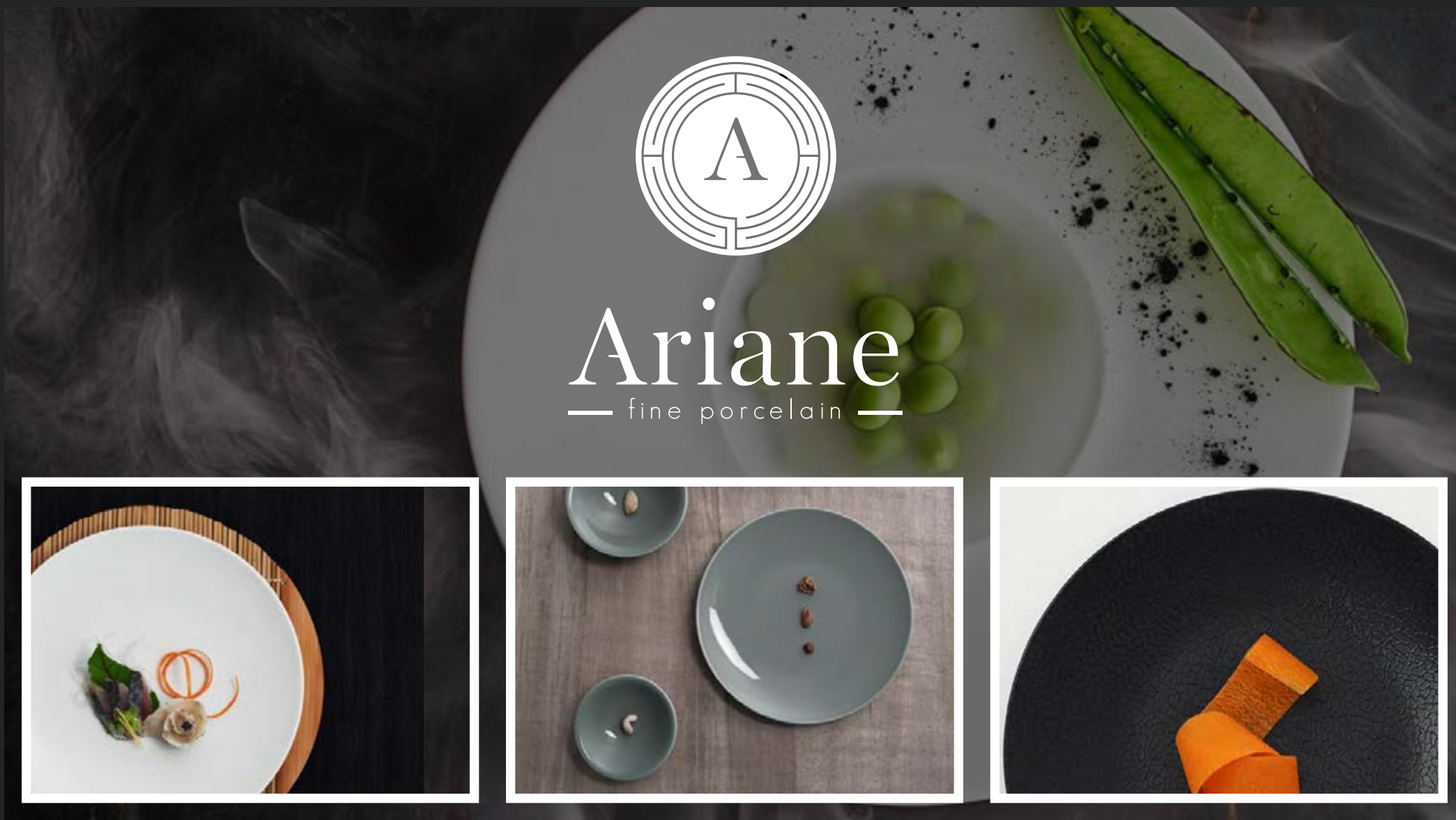

CONTENTS

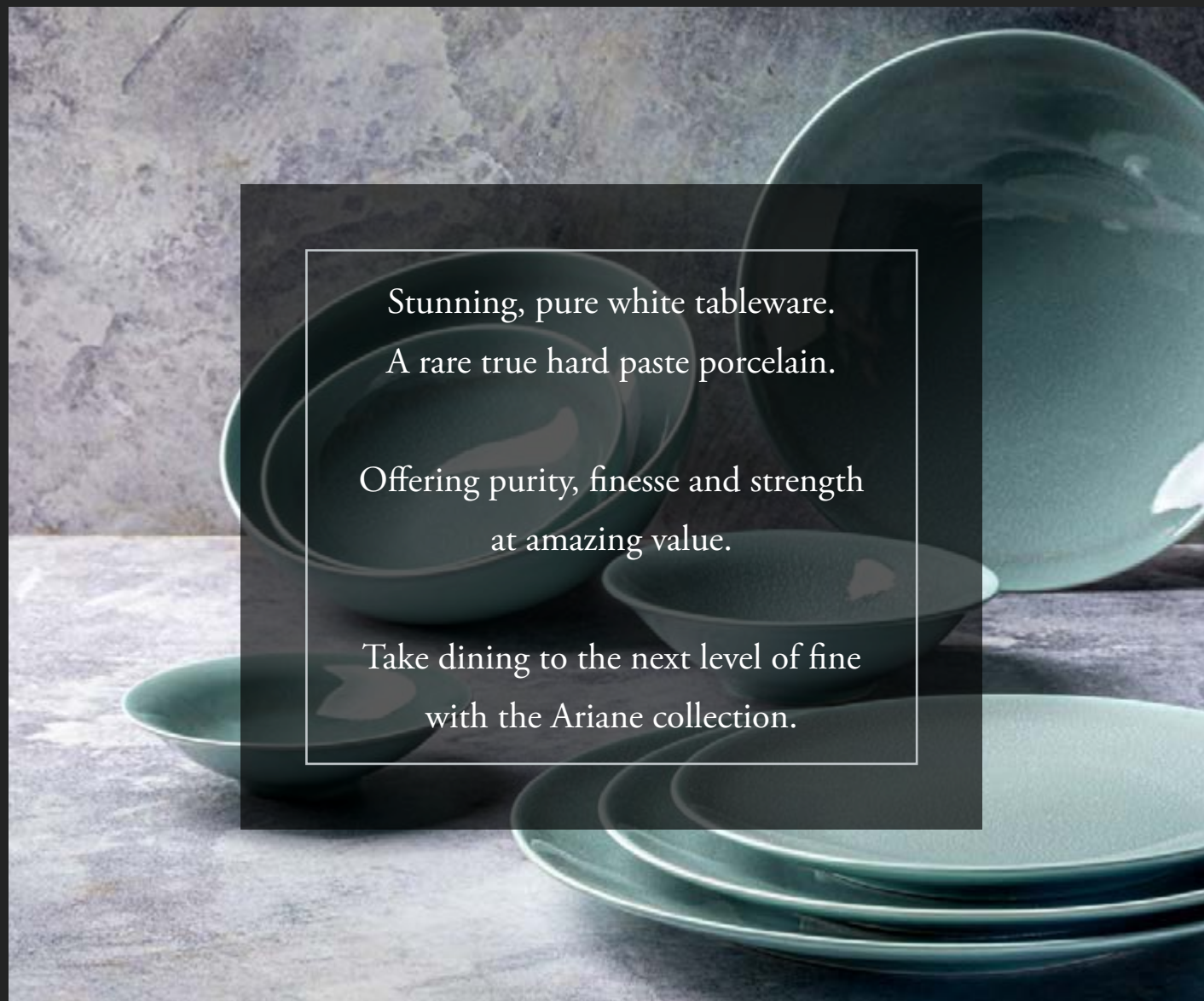

Stunning, pure white tableware.
A rare true hard paste porcelain.

Offering purity, finesse and strength
at amazing value.

Take dining to the next level of fine
with the Ariane collection.

JAVEIL COLLECTION



Coupe Plates

01	BP860GY	Coupe Plate 11", 28cm - Ash Grey	Case Qty 6
02	BP861GY	Coupe Plate 9", 25cm - Ash Grey	Case Qty 6
03	BP862GY	Coupe Plate 8", 22cm - Ash Grey	Case Qty 6
04	BQ044GY	Coupe Bowl 11", 28cm - Ash Grey	Case Qty 4
05	BQ045GY	Coupe Bowl 10", 25cm - Ash Grey	Case Qty 6
06	BP860GN	Coupe Plate 11", 28cm - Sea Green	Case Qty 6
07	BP861GN	Coupe Plate 9", 25cm - Sea Green	Case Qty 6
08	BP862GN	Coupe Plate 8", 22cm - Sea Green	Case Qty 6
09	BQ044GN	Coupe Bowl 11", 28cm - Sea Green	Case Qty 4
10	BQ045GN	Coupe Bowl 10", 25cm - Sea Green	Case Qty 6
11	BP860TE	Coupe Plate 11", 28cm - Velvet Teal	Case Qty 6
12	BP861TE	Coupe Plate 9", 25cm - Velvet Teal	Case Qty 6
13	BP862TE	Coupe Plate 8", 22cm - Velvet Teal	Case Qty 6
14	BQ044TE	Coupe Bowl 11", 28cm - Velvet Teal	Case Qty 4
15	BQ045TE	Coupe Bowl 10", 25cm - Velvet Teal	Case Qty 6

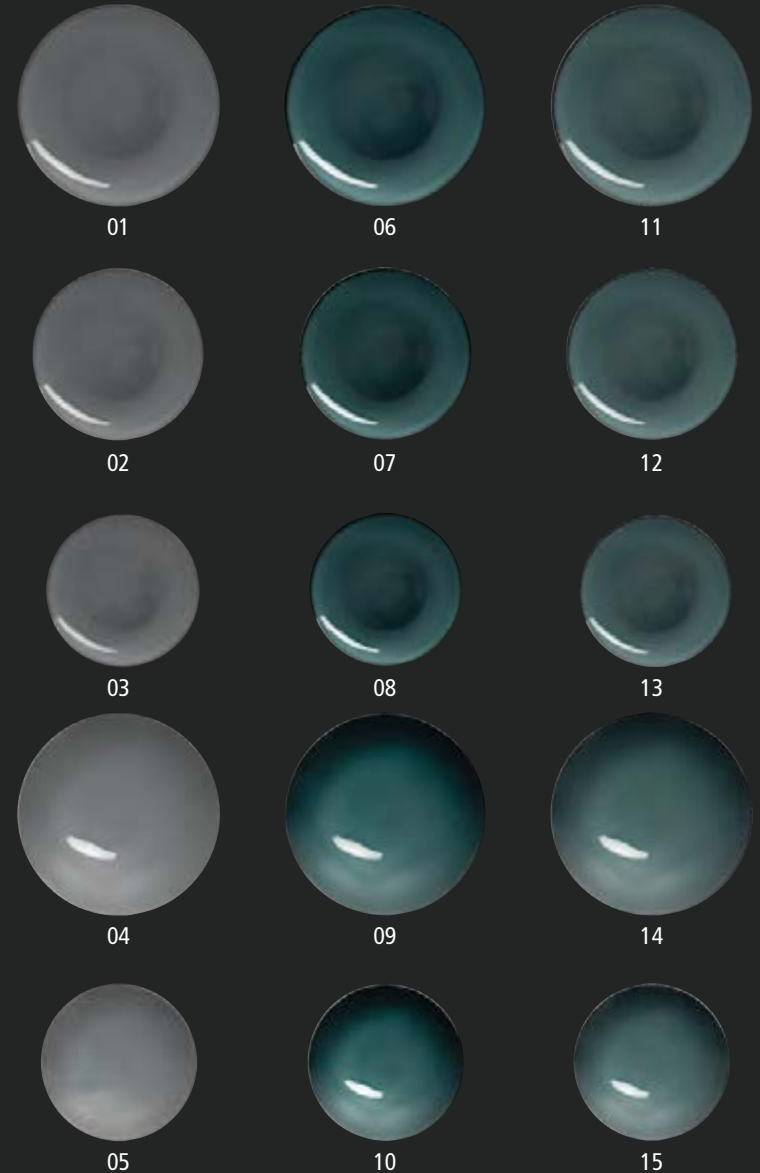

AIRAIN COLLECTION



Coupe Plates



- 01 **BP869** Coupe Plate 11", 28cm - Metallic Case Qty 6
- 02 **BP870** Coupe Plate 9 1/2", 25cm - Metallic Case Qty 6
- 03 **BP871** Coupe Plate 8 1/2", 22cm - Metallic Case Qty 6
- 04 **BP863** Coupe Plate 5 1/10", 15cm - Bronze Case Qty 24



Bowls

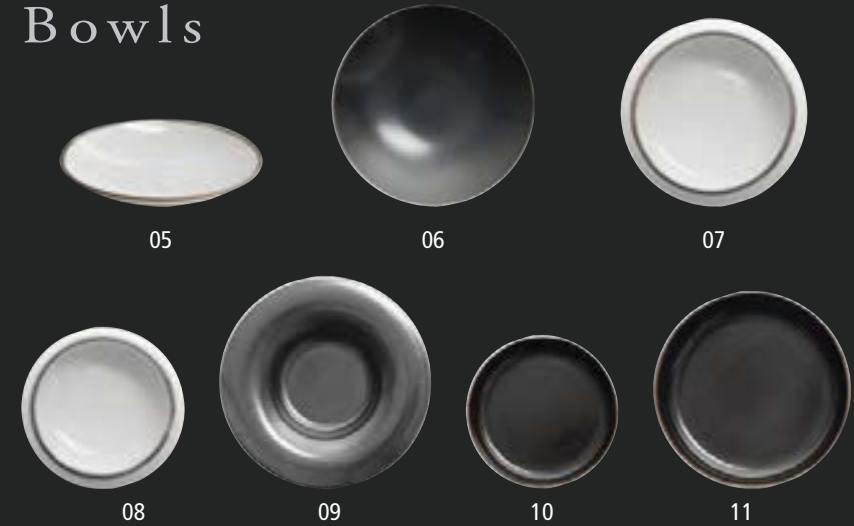

- 05 **BP872** Coupe Bowl 7 1/2", 20cm - Metallic Case Qty 6
- 06 **BP864** Coupe Bowl 9 1/2", 25cm - Bronze Case Qty 6
- 07 **BP873** Organic Bowl 6 1/2", 16cm - Metallic Case Qty 6
- 08 **BP874** Organic Bowl 5 1/2", 13cm - Metallic Case Qty 6
- 09 **BP868** Gourmet Bowl 10 1/4", 26cm - Bronze Case Qty 6
- 10 **BP867** Side Bowl 5 1/16", 15cm - Bronze Case Qty 6
- 11 **BP866** Side Bowl 4", 12cm - Bronze Case Qty 12

Jug



- 12 **BP865** Jug 4 1/2oz, 12.5cl - Bronze Case Qty 6



PEEL COLLECTION



Plates

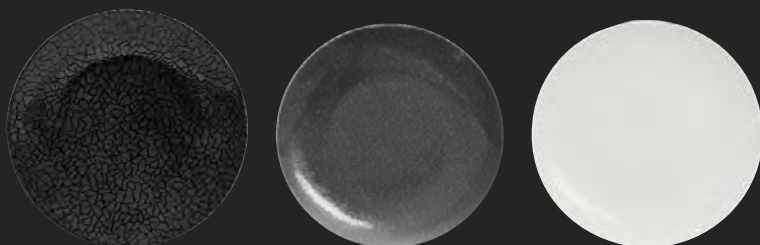

01

02

03



04

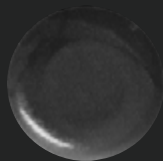

05

- | | | | |
|----|--------------|---------------------------------------------------|------------|
| 01 | BP850 | Coupe Plate 12 $\frac{1}{2}$ " , 31cm - Black | Case Qty 6 |
| 02 | BP853 | Coupe Flat Plate 11" , 28cm - Slate | Case Qty 6 |
| 03 | BP856 | Coupe Flat Plate 11" , 28cm - White | Case Qty 6 |
| 04 | BP857 | Coupe Flat Plate 9 $\frac{1}{2}$ " , 25cm - White | Case Qty 6 |
| 05 | BP851 | Coupe Plate 5 $\frac{1}{10}$ " , 15cm - Black | Case Qty 6 |



Bowls

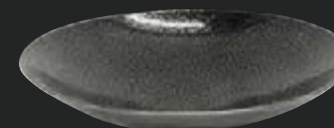

06



07

- | | | | |
|----|--------------|---------------------------------------------|------------|
| 06 | BP854 | Coupe Bowl 9 $\frac{1}{2}$ " , 25cm - Slate | Case Qty 6 |
| 07 | BP858 | Coupe Bowl 7 $\frac{1}{2}$ " , 20cm - White | Case Qty 6 |

Platters



08



09



10

- | | | | |
|----|--------------|-------------------------------------------------------------------|------------|
| 08 | BP852 | Plate 13 $\frac{1}{4}$ x 5 $\frac{1}{10}$ " , 35 x 15cm - Black | Case Qty 6 |
| 09 | BP855 | Platter 14 $\frac{1}{10}$ x 8 $\frac{1}{5}$ " , 38 x 22cm - Slate | Case Qty 6 |
| 10 | BP859 | Flat Platter 11" , 28cm - White | Case Qty 6 |



STYLE COLLECTION



Wide Rim Plates & Bowls

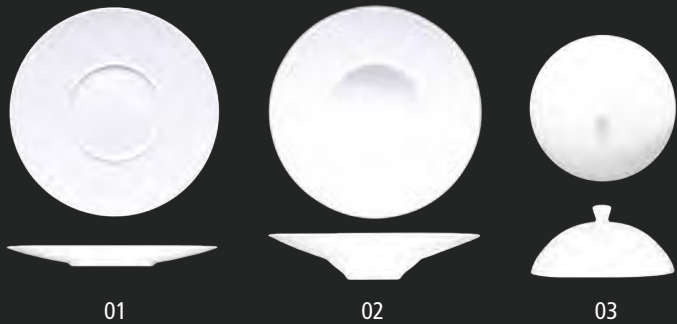

- | | | | |
|----|---------------|---------------------------------------------------------|------------|
| 01 | BI2196 | Wide Rimmed Plate 11", 28cm | Case Qty 6 |
| 01 | BI297 | Wide Rimmed Plate 8 ² / ₃ ", 22cm | Case Qty 6 |
| 02 | BI294 | Wide Rimmed Bowl 11", 28cm | Case Qty 6 |
| 02 | BI295 | Wide Rimmed Bowl 8 ² / ₃ ", 22cm | Case Qty 6 |
| 03 | BI298 | Cloche to fit BI296 & BI294 | Case Qty 1 |
| 03 | BI299 | Cloche to fit BI297 & BI295 | Case Qty 1 |

Plates

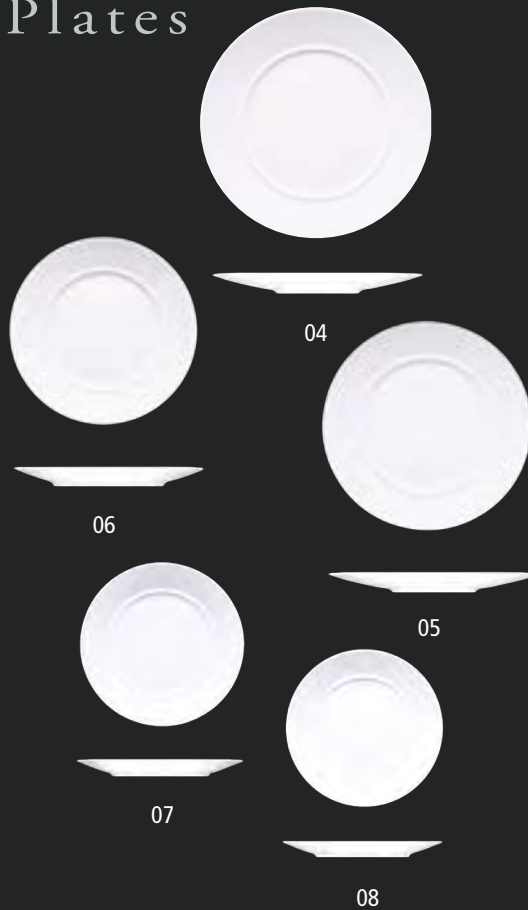

- | | | | |
|----|--------------|----------------------------------------------|-------------|
| 04 | BI287 | Plate 12 ¹ / ₂ ", 31cm | Case Qty 4 |
| 05 | BI288 | Plate 11", 28cm | Case Qty 6 |
| 06 | BI289 | Plate 9 ¹ / ₂ ", 25cm | Case Qty 6 |
| 07 | BI290 | Plate 8 ¹ / ₂ ", 22cm | Case Qty 6 |
| 08 | BI291 | Plate 6 ¹ / ₂ ", 17cm | Case Qty 12 |

Coupe Plates

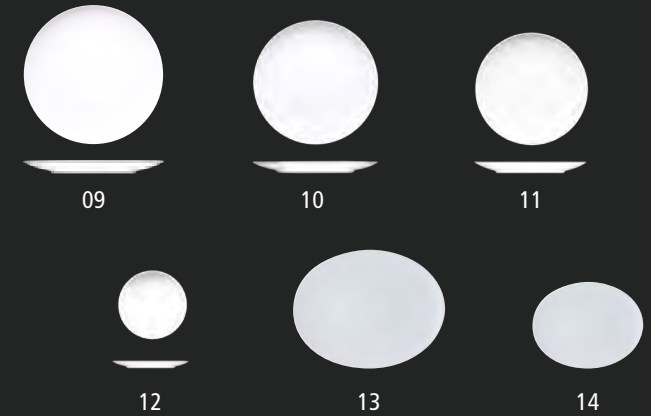

- | | | | |
|----|---------------|----------------------------------------------------|-------------|
| 09 | BI313 | Coupe Plate 12 ¹ / ₂ ", 31cm | Case Qty 4 |
| 10 | BI314 | Coupe Plate 11", 28cm | Case Qty 6 |
| 11 | BI315 | Coupe Plate 9 ¹ / ₂ ", 25cm | Case Qty 6 |
| 12 | BI316 | Coupe Plate 6 ¹ / ₂ ", 17cm | Case Qty 12 |
| 13 | AR5041 | Oval Coupe Plate 13", 33cm | Case Qty 4 |
| 14 | AR5042 | Oval Coupe Plate 9", 23cm | Case Qty 6 |



STYLE COLLECTION

Bowls

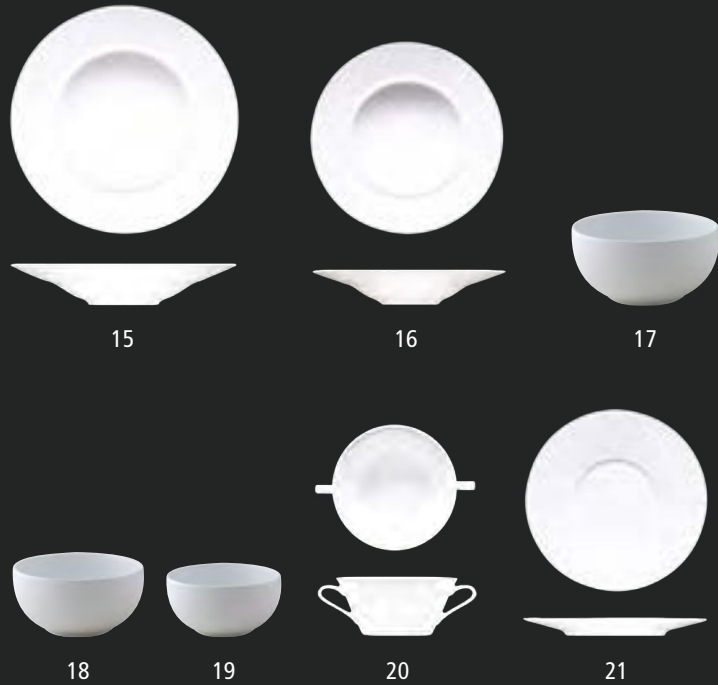

- | | | | |
|----|---------------|---------------------------------------|-------------|
| 15 | BI292 | Rimmed Bowl 11 $\frac{1}{2}$ " , 30cm | Case Qty 4 |
| 16 | BI293 | Rimmed Bowl 9 $\frac{1}{2}$ " , 25cm | Case Qty 4 |
| 17 | AR5036 | Side Bowl 6 $\frac{1}{2}$ " , 16cm | Case Qty 6 |
| 18 | AR5037 | Side Bowl 5 $\frac{1}{2}$ " , 14cm | Case Qty 6 |
| 19 | BQ063 | Side Bowl 4 $\frac{1}{2}$ " , 12cm | Case Qty 12 |
| 20 | BI303 | Handled Soup Bowl 10oz, 30cl | Case Qty 1 |
| 21 | BI306* | Round Soup Stand 7" , 18cm | Case Qty 6 |

Beverage & Accessories



- | | | | |
|----|---------------|---------------------------------------|-------------|
| 22 | BL903 | Cup 9 $\frac{1}{2}$ oz, 27cl | Case Qty 6 |
| 23 | BI304 | Cup 7oz, 20cl | Case Qty 12 |
| 24 | BI305 | Cup 3oz, 9cl | Case Qty 12 |
| 25 | BI309 | Mug 10oz, 30cl | Case Qty 6 |
| 26 | BI307* | Large Saucer 6 $\frac{1}{2}$ " , 16cm | Case Qty 24 |
| 27 | BI308* | Small Saucer 5 $\frac{1}{2}$ " , 14cm | Case Qty 24 |
| 28 | BI312 | Teapot 14oz, 40cl | Case Qty 2 |
| 29 | AR5035 | Jug / Sauce Boat 9oz, 25cl | Case Qty 6 |
| 29 | BI311 | Jug / Sauce Boat 5oz, 15cl | Case Qty 6 |
| 30 | DL802 | Salt Pot | Case Qty 12 |
| 30 | DL803 | Pepper Pot | Case Qty 6 |

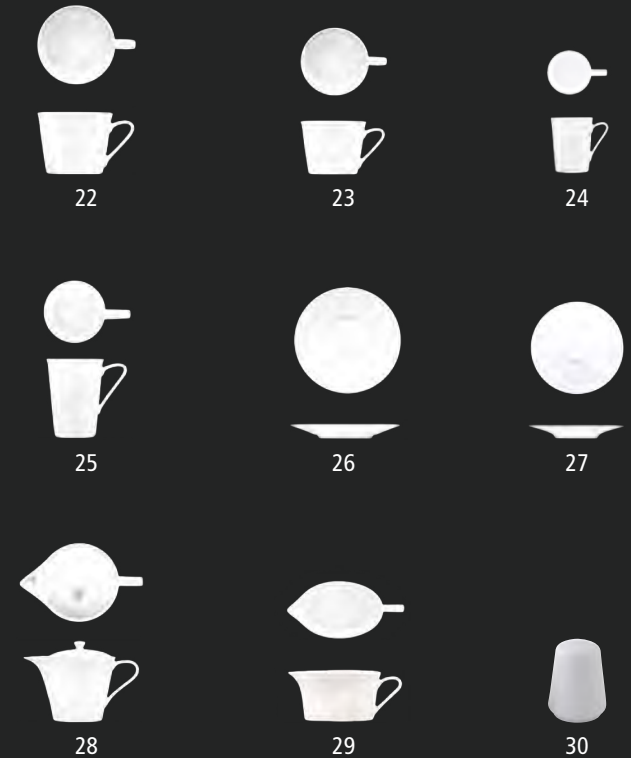

*BI307 FITS CUP BI304, BI308 FITS CUP BI305

STYLE COLLECTION



Coupe Bowls



33

33 **B1300** Coupe Bowl 9 $\frac{1}{8}$ " , 25cm



34

34 **B1301** Coupe Bowl 7 $\frac{1}{8}$ " , 20cm Case Qty 6



Bowls



31

31 **BK022** Square Side Bowl 5 $\frac{1}{2}$ " , 14cm Case Qty 12



32

32 **BK023** Round Side Bowl 5 $\frac{9}{10}$ " , 15cm Case Qty 6

Signature Pieces



35

35 **BK019*** Flat Platter 11" , 29cm Case Qty 6



36

36 **BK021** Burger Platter 12 $\frac{1}{8}$ " x 5 $\frac{1}{10}$ " , 32 x 15cm Case Qty 6

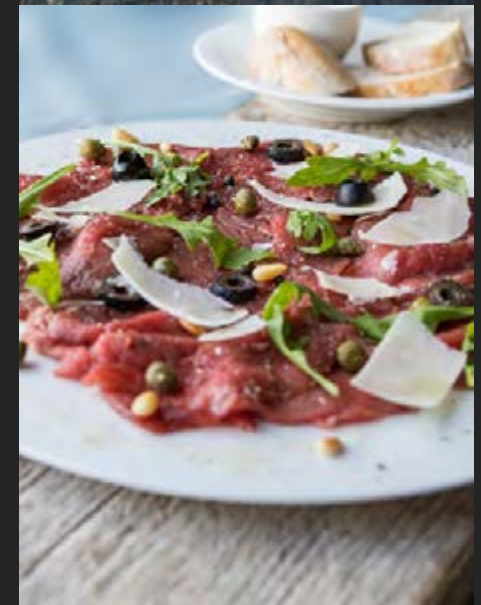

*BK019 FITS
RAFTERS PLATTER
DK271 (page 242)

BRASSERIE COLLECTION



01

02

03



04

05

Plates

- | | | | |
|----|--------------|---------------------------------|-------------|
| 01 | BI318 | Plate 12 $\frac{1}{2}$ " , 31cm | Case Qty 4 |
| 02 | BI319 | Plate 10 $\frac{1}{2}$ " , 27cm | Case Qty 6 |
| 03 | BI320 | Plate 9 $\frac{1}{2}$ " , 24cm | Case Qty 6 |
| 04 | BI321 | Plate 8 $\frac{1}{4}$ " , 21cm | Case Qty 6 |
| 05 | BI322 | Plate 6" , 15cm | Case Qty 24 |

Bowls



06

07

- | | | | |
|----|--------------|---------------------------------------|------------|
| 06 | BI323 | Rimmed Bowl 11 $\frac{1}{2}$ " , 29cm | Case Qty 4 |
| 07 | BI324 | Rimmed Bowl 9" , 23cm | Case Qty 6 |

Beverage & Accessories



08

09

10



11

12



13

14

15

- | | | | |
|----|---------------|---------------------------------------|-------------|
| 08 | BI327 | Stacking Cup 7 $\frac{1}{2}$ oz, 22cl | Case Qty 12 |
| 09 | BI328 | Stacking Cup 3oz, 9cl | Case Qty 12 |
| 10 | BI329* | Large Saucer 6 $\frac{1}{3}$ " , 15cm | Case Qty 24 |
| 11 | BI330* | Small Saucer 5" , 13cm | Case Qty 24 |
| 12 | BI310 | Covered Sugar Bowl 7oz, 20cl | Case Qty 6 |
| 13 | BI325 | Jug 7oz, 20cl | Case Qty 6 |
| 14 | BI326 | Jug 3 $\frac{1}{2}$ oz, 10cl | Case Qty 6 |
| 15 | BI317 | Butter Block 2oz, 6cl | Case Qty 12 |

*BI329 FITS CUP BI327, BI330 FITS CUP BI328

THE QUALITY OF ARIANE

CREATING A TRUE WHITE PORCELAIN

There is a reason why hard paste porcelain is called 'True Porcelain'. True Porcelain is only made by real craftsmen, those who have the ability to combine the science with the art.

Often imitated; true porcelain is the ultimate ceramic material; more dense, harder, stronger, and more durable. From its Chinese origins, through the master potters of France and Germany it has been the tableware of choice for those who can afford real luxury.

A tour across the finest restaurants of the world will, time after time, show wonderful gastronomy displayed to its very best advantage on true porcelain.

The finest, purest materials, the highest firing temperatures, minute control of atmospheric conditions are what make true porcelain a rare commodity. The end result is incredible finesse, the purest white and the ability to produce stunning shapes.

MATERIALS

- Ariane uses only the purest China Clays and China Stone
- Free from artificial fluxes and fillers
- High firing temperatures to fuse the clays into a dense, highly durable, pure white porcelain
- Highest grade alumina to bring a unique level of durability
- Finest European material along with a level of quality testing and control rare in the tableware industry
- High quality, lead free glaze finish

MANUFACTURING

- Manufactured using all the latest equipment and kilns
- Firing: First Firing (Biscuit/Bisque) at 1000°C to get a dry, porous blank ready for glazing. Second Firing (Glost/ Grand Feu) at over 1400°C. Exact control of the oxygen content in the glost kiln is crucial to developing the colour and vitrifying the porcelain perfectly.
- Forming: Ariane utilises the latest techniques – isostatic pressing, high pressure casting, new generation cup/mug forming machines
- Glazing: The latest German automated glaze dipping cell
- Finishing: Ariane is foot polished using a diamond polishing machine for a glassy finish

QUALITY MANAGEMENT

- Exclusively manufactured in a world-class facility that has been awarded ISO9001 for quality management,
- The factory utilises the latest forming, finishing and firing technology to guarantee consistency, efficiency and effective environmental control throughout every process.
- Continuous and rigorous testing at every stage throughout the process
- 100% inspections by staff dedicated to the elimination of faults
- Holding certification for Corporate Social Responsibility to SA8000, the care and well being of the employees & their families is of the utmost importance.
- The factory also holds certification for Environmental Management ISO14000.

PRODUCT CARE - HOW TO GET THE BEST FROM ARIANE TABLEWARE

STACKING

- Stack items vertically
- Avoid one item sliding or rubbing against another

CHIPPING

The vast majority of Ariane (all plates, bowls, oval dishes, saucers, cups and mugs) are covered by a lifetime edge chip warranty but it's important to follow these basic guidelines:

- Always handle with care – careless or rough handling causes breakages
- Never scrape the product against a bin or receptacle

IN THE DISHWASHER

- Rinse thoroughly after use, before loading into a dishwasher
- Wash separately from other items like glassware, cutlery and cooking equipment
- Follow the dishwasher manufacturer guidelines for type and amount of detergent to use
- Keep the dishwasher fully serviced and clean as per manufacturer guidelines
- If metal marks do appear on Ariane items, clean with a porcelain cleanser. Check cutlery to ensure there no rough edges
- Wash metal surfaces with water & vinegar to remove any particles which could be transferred.



**LIFETIME EDGE
CHIP WARRANTY**



MICROWAVE SAFE



DISHWASHER SAFE



HEAT RETENTION



**THERMAL SHOCK
RESISTANCE**



**ABRASION &
METAL MARKING
RESISTANCE**



STACKABILITY



**LEAD AND
CADMIUM FREE**

CUTLERY

Signature
COLLECTION

82

twentyeight

93



SIGNATURE - CUTLERY

Signature
COLLECTION



CONTENTS

AIR SIDE CUTLERY

SIGNATURE STYLE

ECONOMY CUTLERY

SIGNATURE STEEL

SPECIALITY CUTLERY



AIR SIDE CUTLERY

Complies with airport air side regulations for "Sharps & Tools"



Plaza Aviation

- 01 **AB633** Plaza Aviation Table Knife Case Qty 12
- 02 **AB634** Plaza Aviation Table Fork Case Qty 12
- 03 **AB635** Plaza Aviation Table Spoon Case Qty 12

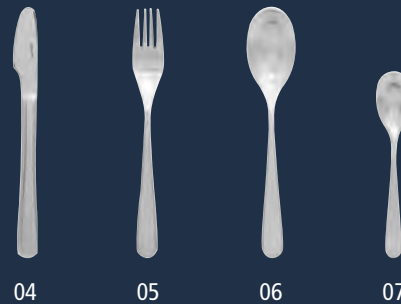

Highgrove Airport

- 04 **AB636** Highgrove Airport Knife Case Qty 12
- 05 **AB637** Highgrove Airport Fork Case Qty 12
- 06 **AB638** Highgrove Airport Spoon Case Qty 12
- 07 **AB639** Highgrove Airport Tea Spoon Case Qty 12

ECONOMY CUTLERY

Economical cutlery for caterers on a tight budget



Economy Plain

- 08 **PRAB991** Plain Table Knife Case Qty 48
- 09 **PRAB992** Plain Table Fork Case Qty 48
- 10 **PRAB993** Plain Dessert Spoon Case Qty 48
- 11 **PRAB994** Plain Tea Spoon Case Qty 48

Signature
STEEL



Economy Harley

- 12 **PRAB995** Harley Table Knife Case Qty 48
- 13 **PRAB996** Harley Table Fork Case Qty 48
- 14 **PRAB997** Harley Dessert Spoon Case Qty 48
- 15 **PRAB998** Harley Tea Spoon Case Qty 48

Signature
STEEL

SIGNATURE STEEL

The Signature Steel ranges are a collection of 18/0 stainless steel patterns, providing an excellent balance between quality and value for money. They are ideal for high volume operations working to a tight budget.

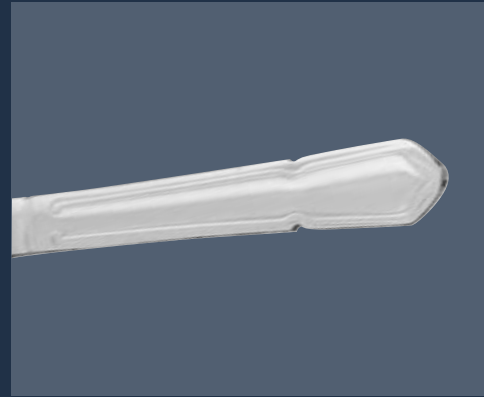
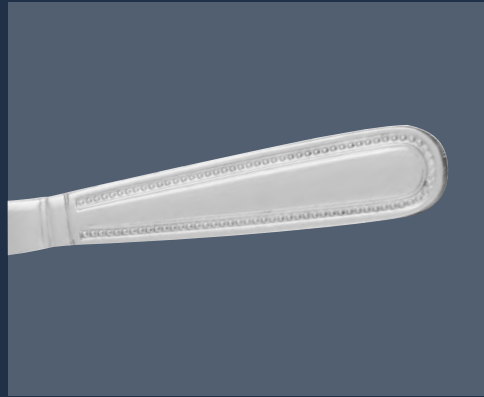

New Era

18/0
Stainless Steel

AB754 Table Knife	Case Qty 12
AB755 Table Fork	Case Qty 12
AB756 Table Spoon	Case Qty 12
AB757 Dessert Knife	Case Qty 12
AB758 Dessert Fork	Case Qty 12
AB759 Dessert Spoon	Case Qty 12
AB760 Soup Spoon	Case Qty 12
AB761 Tea Spoon	Case Qty 12
AB762 Coffee Spoon	Case Qty 12
AD952 Cake Fork	Case Qty 12
AB763 Soda Spoon, 21cm	Case Qty 12
AB708 Infants Knife	Case Qty 12
AB709 Infants Fork	Case Qty 12
AB710 Infants Spoon	Case Qty 12

Bead

18/0
Stainless Steel

AB745 Table Knife (S/H)	Case Qty 12
AB746 Table Fork	Case Qty 12
AB748 Dessert Knife (S/H)	Case Qty 12
AB749 Dessert Fork	Case Qty 12
AB750 Dessert Spoon	Case Qty 12
AB751 Soup Spoon	Case Qty 12
AB752 Tea Spoon	Case Qty 12
AB753 Coffee Spoon	Case Qty 12
A7431 Cake Fork	Case Qty 12
A1575 Steak Knife (S/H)	Case Qty 12

Dubarry

18/0
Stainless Steel

AB711 Table Knife (S/H)	Case Qty 12
AB712 Table Fork	Case Qty 12
AB713 Table Spoon	Case Qty 12
AB714 Dessert Knife (S/H)	Case Qty 12
AB715 Dessert Fork	Case Qty 12
AB716 Dessert Spoon	Case Qty 12
AB717 Soup Spoon	Case Qty 12
AB718 Tea Spoon	Case Qty 12

Harley

18/0
Stainless Steel

A7503 Table Knife (H/H)	Case Qty 12
AB734 Table Knife (S/H)	Case Qty 12
AB727 Table Fork	Case Qty 12
AB728 Table Spoon	Case Qty 12
A1527A Steak Knife	Case Qty 12
A7504 Dessert Knife (H/H)	Case Qty 12
AB735 Dessert Knife (S/H)	Case Qty 12
AB729 Dessert Fork	Case Qty 12
AB730 Dessert Spoon	Case Qty 12
AB731 Soup Spoon	Case Qty 12
AB732 Tea Spoon	Case Qty 12
AB733 Coffee Spoon	Case Qty 12

SIGNATURE STEEL

The Signature Steel ranges are a collection of 18/0 stainless steel patterns, providing an excellent balance between quality and value for money. They are ideal for high volume operations working to a tight budget.

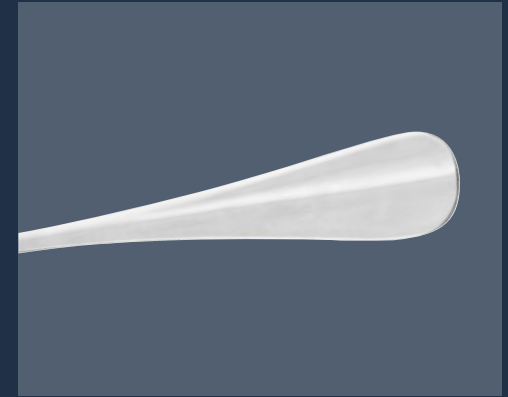
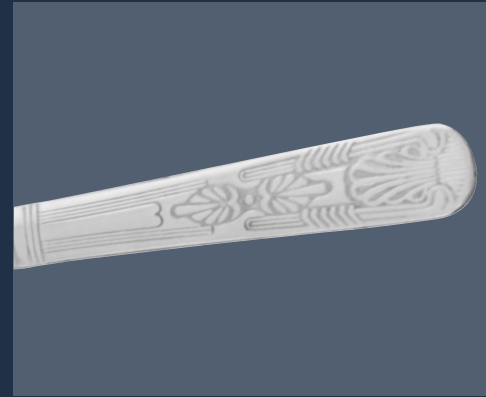
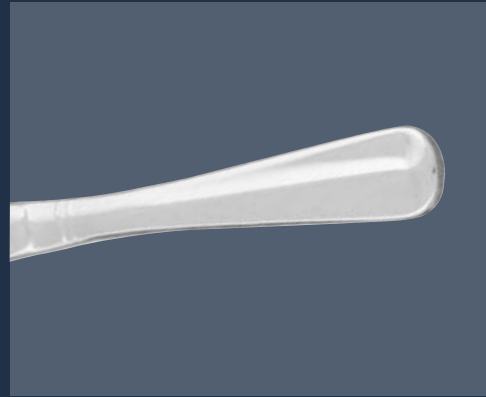
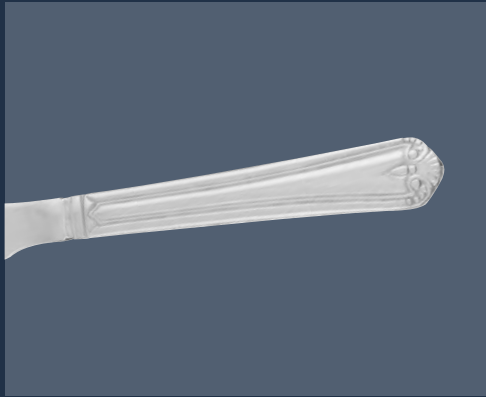

Jesmond

18/0
Stainless Steel

AB764 Table Knife (S/H)	Case Qty 12
AB738 Table Fork	Case Qty 12
AB744 Dessert Knife (S/H)	Case Qty 12
AB740 Dessert Fork	Case Qty 12
AB741 Dessert Spoon	Case Qty 12
AB742 Soup Spoon	Case Qty 12
AB743 Tea Spoon	Case Qty 12

Rattail

18/0
Stainless Steel

AD509 Table Knife (S/H)	Case Qty 12
AD510 Table Fork	Case Qty 12
AD511 Dessert Knife (S/H)	Case Qty 12
AD512 Dessert Fork	Case Qty 12
AD513 Dessert Spoon	Case Qty 12
AD514 Soup Spoon	Case Qty 12
AD515 Tea Spoon	Case Qty 12

Kings

18/0
Stainless Steel

A7389 Table Knife (H/H)	Case Qty 12
AB736 Table Knife (S/H)	Case Qty 12
AB720 Table Fork	Case Qty 12
AB721 Table Spoon	Case Qty 12
A7392 Dessert Knife (H/H)	Case Qty 12
AB737 Dessert Knife (S/H)	Case Qty 12
AB722 Dessert Fork	Case Qty 12
AB723 Dessert Spoon	Case Qty 12
AB724 Soup Spoon	Case Qty 12
AB725 Tea Spoon	Case Qty 12
AB726 Coffee Spoon	Case Qty 12
A1336 Cake Fork	Case Qty 12
A0878 Steak Knife (S/H)	Case Qty 12

Baguette

18/0
Stainless Steel

AB589 Table Knife	Case Qty 12
AB590 Table Fork	Case Qty 12
AB592 Dessert Knife	Case Qty 12
AB593 Dessert Fork	Case Qty 12
AB594 Dessert Spoon	Case Qty 12
AB595 Soup Spoon	Case Qty 12
AB596 Tea Spoon	Case Qty 12

SIGNATURE STYLE

The Signature Style range of cutlery offers a comprehensive range of styles, shapes and finishes designed to provide the perfect accompaniment to any dining experience.



Lichfield

18/0
Stainless Steel

AB621 Table Knife	Case Qty 12
AB622 Table Fork	Case Qty 12
AB623 Table Spoon	Case Qty 12
AB624 Dessert Knife	Case Qty 12
AB625 Dessert Fork	Case Qty 12
AB626 Dessert Spoon	Case Qty 12
AB627 Soup Spoon	Case Qty 12
AB628 Tea Spoon	Case Qty 12

Cambridge

18/0
Stainless Steel

AB559 Table Knife	Case Qty 12
AB560 Table Fork	Case Qty 12
AB561 Dessert Knife	Case Qty 12
AB562 Dessert Fork	Case Qty 12
AB563 Dessert Spoon	Case Qty 12
AB564 Soup Spoon	Case Qty 12
AB565 Tea Spoon	Case Qty 12

Lincoln

18/0
Stainless Steel

AB566 Table Knife	Case Qty 12
AB567 Table Fork	Case Qty 12
AB568 Table Spoon	Case Qty 12
AB569 Dessert Knife	Case Qty 12
AB570 Dessert Fork	Case Qty 12
AB571 Dessert Spoon	Case Qty 12
AB572 Soup Spoon	Case Qty 12
AB573 Tea Spoon	Case Qty 12

Canterbury

18/0
Stainless Steel

AB574 Table Knife	Case Qty 12
AB575 Table Fork	Case Qty 12
AB576 Dessert Knife	Case Qty 12
AB577 Dessert Fork	Case Qty 12
AB578 Dessert Spoon	Case Qty 12
AB579 Soup Spoon	Case Qty 12
AB580 Tea Spoon	Case Qty 12



Signature
STYLE

SIGNATURE STYLE

The Signature Style range of cutlery offers a comprehensive range of styles, shapes and finishes designed to provide the perfect accompaniment to any dining experience.

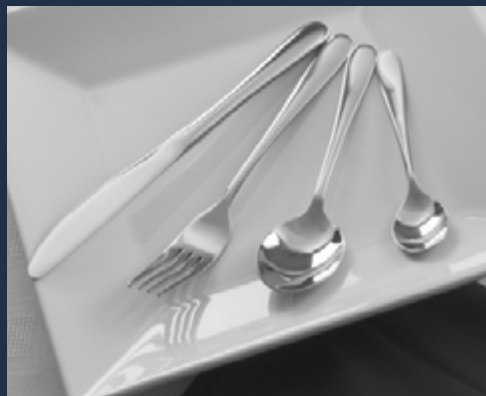

Ascot/Venus 18/0

Stainless Steel

- AB640 Table Knife Case Qty 12
- AB641 Table Fork Case Qty 12
- AB642 Dessert Knife Case Qty 12
- AB643 Dessert Fork Case Qty 12
- AB644 Dessert Spoon Case Qty 12
- AB645 Soup Spoon Case Qty 12
- AB646 Tea Spoon Case Qty 12

New English 18/0

Stainless Steel

- AB766 Table Knife Case Qty 12
- AB767 Table Fork Case Qty 12
- AB768 Dessert Spoon Case Qty 12
- AB769 Soup Spoon Case Qty 12
- AB770 Tea Spoon Case Qty 12

Salisbury 18/0

Stainless Steel

- AB581 Table Knife Case Qty 12
- AB582 Table Fork Case Qty 12
- AB583 Table Spoon Case Qty 12
- AB584 Dessert Knife Case Qty 12
- AB585 Dessert Fork Case Qty 12
- AB586 Dessert Spoon Case Qty 12
- AB587 Soup Spoon Case Qty 12
- AB588 Tea Spoon Case Qty 12

Winchester 18/0

Stainless Steel

- AB597 Table Knife Case Qty 12
- AB598 Table Fork Case Qty 12
- AB600 Dessert Knife Case Qty 12
- AB601 Dessert Fork Case Qty 12
- AB602 Dessert Spoon Case Qty 12
- AB603 Soup Spoon Case Qty 12
- AB604 Tea Spoon Case Qty 12

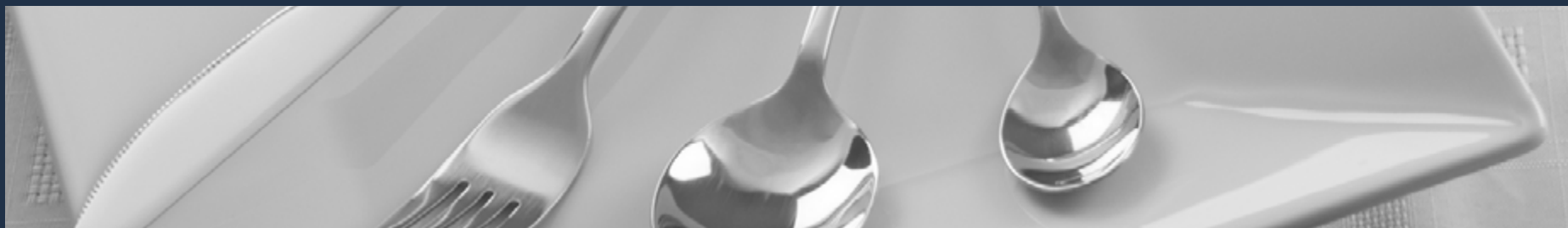

Signature
STYLE

SIGNATURE STYLE

The Signature Style range of cutlery offers a comprehensive range of styles, shapes and finishes designed to provide the perfect accompaniment to any dining experience.



Stirling

18/0
Stainless Steel

AB613 Table Knife	Case Qty 12
AB614 Table Fork	Case Qty 12
AB615 Table Spoon	Case Qty 12
AB616 Dessert Knife	Case Qty 12
AB617 Dessert Fork	Case Qty 12
AB618 Dessert Spoon	Case Qty 12
AB619 Soup Spoon	Case Qty 12
AB620 Tea Spoon	Case Qty 12

Caroline

18/10
Stainless Steel

AB650 Table Knife	Case Qty 12
AB651 Table Fork	Case Qty 12
AB652 Table Spoon	Case Qty 12
AB653 Dessert Knife	Case Qty 12
AB654 Dessert Fork	Case Qty 12
AB655 Dessert Spoon	Case Qty 12
AB656 Soup Spoon	Case Qty 12
AB657 Tea Spoon	Case Qty 12
AB649 Soda Spoon, 20.8cm	Case Qty 12

Stephanie

18/10
Stainless Steel

AB665 Table Knife	Case Qty 12
AB666 Table Fork	Case Qty 12
AB667 Table Spoon	Case Qty 12
AB668 Dessert Knife	Case Qty 12
AB669 Dessert Fork	Case Qty 12
AB670 Dessert Spoon	Case Qty 12
AB671 Soup Spoon	Case Qty 12
AB672 Tea Spoon	Case Qty 12

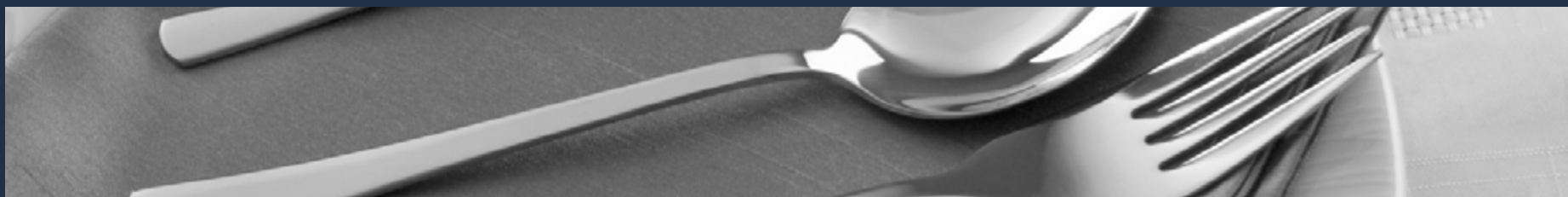

Signature
STYLE

SIGNATURE STYLE

The Signature Style range of cutlery offers a comprehensive range of styles, shapes and finishes designed to provide the perfect accompaniment to any dining experience.



Jasmine

18/10
Stainless Steel

- AB658 Table Knife Case Qty 12
- AB659 Table Fork Case Qty 12
- AB660 Dessert Knife Case Qty 12
- AB661 Dessert Fork Case Qty 12
- AB662 Dessert Spoon Case Qty 12
- AB663 Soup Spoon Case Qty 12
- AB664 Tea Spoon Case Qty 12

York

18/10
Stainless Steel

- AB696 Table Knife Case Qty 12
- AB697 Table Fork Case Qty 12
- AB698 Table Spoon Case Qty 12
- AB700 Dessert Knife Case Qty 12
- AB701 Dessert Fork Case Qty 12
- AB702 Dessert Spoon Case Qty 12
- AB699 Soup Spoon Case Qty 12
- AB704 Fish Fork Case Qty 12
- AB705 Tea Spoon Case Qty 12
- AB706 Coffee Spoon Case Qty 12

Nottingham

18/10
Stainless Steel

- AB684 Table Knife S/H Case Qty 12
- AB685 Table Fork Case Qty 12
- AB686 Table Spoon Case Qty 12
- AB688 Dessert Knife Case Qty 12
- AB689 Dessert Fork Case Qty 12
- AB690 Dessert Spoon Case Qty 12
- AB687 Soup Spoon Case Qty 12
- AB693 Tea Spoon Case Qty 12
- AB694 Coffee Spoon Case Qty 12

Oxford

18/10
Stainless Steel

- AB673 Table Knife Case Qty 12
- AB674 Table Fork Case Qty 12
- AB677 Dessert Knife Case Qty 12
- AB678 Dessert Fork Case Qty 12
- AB679 Dessert Spoon Case Qty 12
- AB676 Soup Spoon Case Qty 12
- AB682 Tea Spoon Case Qty 12



Signature
STYLE

SIGNATURE STYLE

The Signature Style range of cutlery offers a comprehensive range of styles, shapes and finishes designed to provide the perfect accompaniment to any dining experience.



Signature
STYLE



Arundel

18/10
Stainless Steel

- | | | |
|-------|---------------|-------------|
| AD706 | Table Knife | Case Qty 12 |
| AD707 | Table Fork | Case Qty 12 |
| AD876 | Dessert Knife | Case Qty 12 |
| AD877 | Dessert Fork | Case Qty 12 |
| AD708 | Dessert Spoon | Case Qty 12 |
| AD878 | Soup Spoon | Case Qty 12 |
| AD879 | Tea Spoon | Case Qty 12 |
| AD880 | Coffee Spoon | Case Qty 12 |

Signature
STYLE

SPECIALITY CUTLERY



01



02



03



04

Steak Knives

- | | | | |
|----|----------------|------------------------------------------------------|-------------|
| 01 | AB771* | Wooden Handle, 21cm overall, 11cm blade | Case Qty 12 |
| 02 | A1413A* | Wooden Handle, 21.5cm overall, 11.5cm blade | Case Qty 12 |
| 03 | AB647 | Black Polyresin Handle, 21.5cm overall, 11.5cm blade | Case Qty 12 |
| 04 | AA894 | Steak Knife 3 Stud Handle | Case Qty 12 |

*Wooden handled (should not be cleaned in the dishwasher).

The special shape of these Rocher Spoons, not too deep, not too shallow, not too round, will help you produce the perfect smooth, sharp oval Roche. To make a Quenelle simply buy 2 sets of matching spoons.



Rocher Spoons

AE222 Rocher Spoons - 3 Sizes Set of 3



twentyeight

γ δ ε θ ω φ λ ς

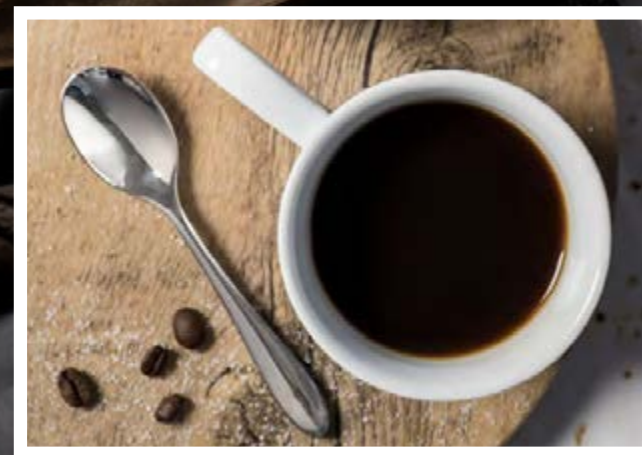

Introducing the **twentyeight** collection

Designed for dining

Twentyeight – a collection of beautiful 18/10 stainless steel cutlery ranges designed specifically for the discerning diner.

Born from a desire to create an exclusive range of completely new cutlery shapes, each one has been styled to enhance any dining experience.

Traditional or modern, classic shape or hybrid shape, delicacy or drama - something to suit every style.

Twentyeight has been designed for dining

γ δ ε θ ω φ λ ς

gamma



DESIGN CONCEPT - GAMMA (WAVE)

Inspired by the rounded curve of the mathematic sine wave. The pieces sit beautifully in the hand and bring a real sense of theatre to the table.



01



02



03



04



05



06



07



08



09

- 01 **AB927** Gamma Table Fork
- 02 **AB926** Gamma Table Knife
- 03 **AB931** Gamma Dessert Fork
- 04 **AB930** Gamma Dessert Knife
- 05 **AB932** Gamma Dessert Spoon
- 06 **AB933** Gamma Steak Knife

- 07 **AB936** Gamma Soup Spoon
- 08 **AB929** Gamma Tea Spoon
- 09 **AD663** Gamma Coffee Spoon



gamma



01



02

Utensils

01 AD674 Gamma Cake Server

02 AD675 Gamma Soup Ladle



delta



DESIGN CONCEPT - DELTA (MINIMALIST)

An exceptionally simple, minimalist design. Smooth rounded lines compliment a minimalist table presentation. Delta is the epitome of 'less is more'.



01 **AB950** Delta Table Fork

02 **AB949** Delta Table Knife

03 **AB954** Delta Dessert Fork

04 **AB953** Delta Dessert Knife

05 **AB955** Delta Dessert Spoon

06 **AB956** Delta Steak Knife

07 **AB960** Delta Soup Spoon

08 **AB952** Delta Tea Spoon

09 **AD666** Delta Coffee Spoon



epsilon

ε

DESIGN CONCEPT - EPSILON (COMFORT)

A classic, solid, teardrop shape designed to deliver maximum comfort with the smooth rounded curves of the handles and the narrow neck.



01



02



03



04



05



06



07



08



09



10



11

- 01 **AB962** Epsilon Table Fork
- 02 **AB961** Epsilon Table Knife
- 03 **AB963** Epsilon Table Spoon
- 04 **AB966** Epsilon Dessert Fork
- 05 **AB965** Epsilon Dessert Knife
- 06 **AB967** Epsilon Dessert Spoon

- 07 **AB968** Epsilon Steak Knife
- 08 **AB972** Epsilon Soup Spoon
- 09 **AB964** Epsilon Tea Spoon

- 10 **AB971** Epsilon Ice Tea Spoon
- 11 **AD664** Epsilon Coffee Spoon



theta



DESIGN CONCEPT - THETA (HYBRID)

A hybrid combination of smooth curves and flat surfaces. A key element of the design is the knife handle - turned through 90° allowing it to curve down to a beautifully slim tapered neck



01 **AB938** Theta Table Fork

02 **AB937** Theta Table Knife

03 **AB942** Theta Dessert Fork

04 **AB941** Theta Dessert Knife

05 **AB943** Theta Dessert Spoon

06 **AB945** Theta Steak Knife

07 **AB944** Theta Soup Spoon

08 **AB940** Theta Tea Spoon



omega



DESIGN CONCEPT - OMEGA (TRADITIONAL)

Designed for the traditional dining experience. Taking inspiration from the 18th Century classic "Bead" pattern but using clean, simple lines to bring a subtle hint of the modern to a traditional table setting.



01 **AB915** Omega Table Fork

02 **AB914** Omega Table Knife

03 **AB919** Omega Dessert Fork

04 **AB918** Omega Dessert Knife

05 **AB920** Omega Dessert Spoon

06 **AB922** Omega Steak Knife

07 **AB921** Omega Soup Spoon

08 **AB917** Omega Tea Spoon



phi



DESIGN CONCEPT - PHI

Dynamic and angular to create a premium and modern aesthetic. Symmetrical tapering from the sloped handle to the slim neck of each individual piece provides a highly stylised collection.

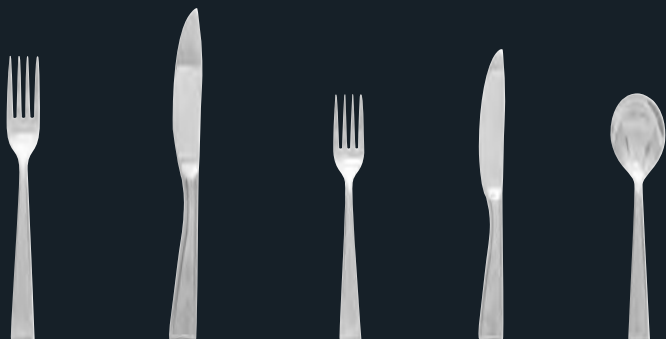

01

02

03

04

05



06

07

08

09

- 01 AE142 Phi Table Fork
- 02 AE141 Phi Table Knife
- 03 AE145 Phi Dessert Fork
- 04 AE144 Phi Dessert Knife
- 05 AE146 Phi Dessert Spoon
- 06 AE150 Phi Steak Knife

- 07 AE147 Phi Soup Spoon
- 08 AE148 Phi Tea Spoon
- 09 AE149 Phi Coffee Spoon



lambda



DESIGN CONCEPT - LAMBDA

Clean, straight lines for a modern, minimalist approach creating a fresh but simple look to the table.



01



02



03



04



05



06



07



08



09

- 01 **AE152** Lambda Table Fork
- 02 **AE151** Lambda Table Knife
- 03 **AE155** Lambda Dessert Fork
- 04 **AE154** Lambda Dessert Knife
- 05 **AE156** Lambda Dessert Spoon
- 06 **AE160** Lambda Steak Knife

- 07 **AE157** Lambda Soup Spoon
- 08 **AE158** Lambda Tea Spoon
- 09 **AE159** Lambda Coffee Spoon



sigma



DESIGN CONCEPT - SIGMA

A lightweight, smooth, classic shape to offer superb comfort at the table.



01



02



03



04



05



06



07



08



09

01 **AE162** Sigma Table Fork

02 **AE161** Sigma Table Knife

03 **AE165** Sigma Dessert Fork

04 **AE164** Sigma Dessert Knife

05 **AE166** Sigma Dessert Spoon

06 **AE170** Sigma Steak Knife

07 **AE167** Sigma Soup Spoon

08 **AE168** Sigma Tea Spoon

09 **AE169** Sigma Coffee Spoon



GLASSWARE

GLACIAL  105

GLACIAL 117

 126



GLACIAL **leco**

NEW



GLACIAL

We are pleased to launch our NEW glassware brand - the Glacial Eco range!

A range that is made from 100% locally sourced recycled bottles without any additives in the manufacturing process.

Glacial Eco is a unique glassware collection combining elegant designs with attractive textures to create stylish tumblers, cocktail glasses, jugs, carafes, dessert glasses and oil bottles. These glasses are skilfully made from recycled glass for a unique and tactile finish. Glacial Eco is a testament to the fact that design, style and quality are perfectly possible to achieve by using 100% recycled glass. Not only that, our new glassware eco range is competitively priced too, making it the perfect affordable sustainable glassware solution.

The manufacturing process for Glacial Eco uses a lower temperature than traditional glass manufacturing, reducing the amount of natural gas that is needed to produce the product. Residues going to landfills are dramatically reduced and extractions of sand and raw materials are minimised. Glacial Eco complies with all the key requirements of the Kyoto Protocol and international treaties that commit parties to reducing greenhouse gases

Welcome to our New Glacial Eco range - A glassware brand that is high on quality, stylish and doesn't cost the earth.



Why Recycled Glass?

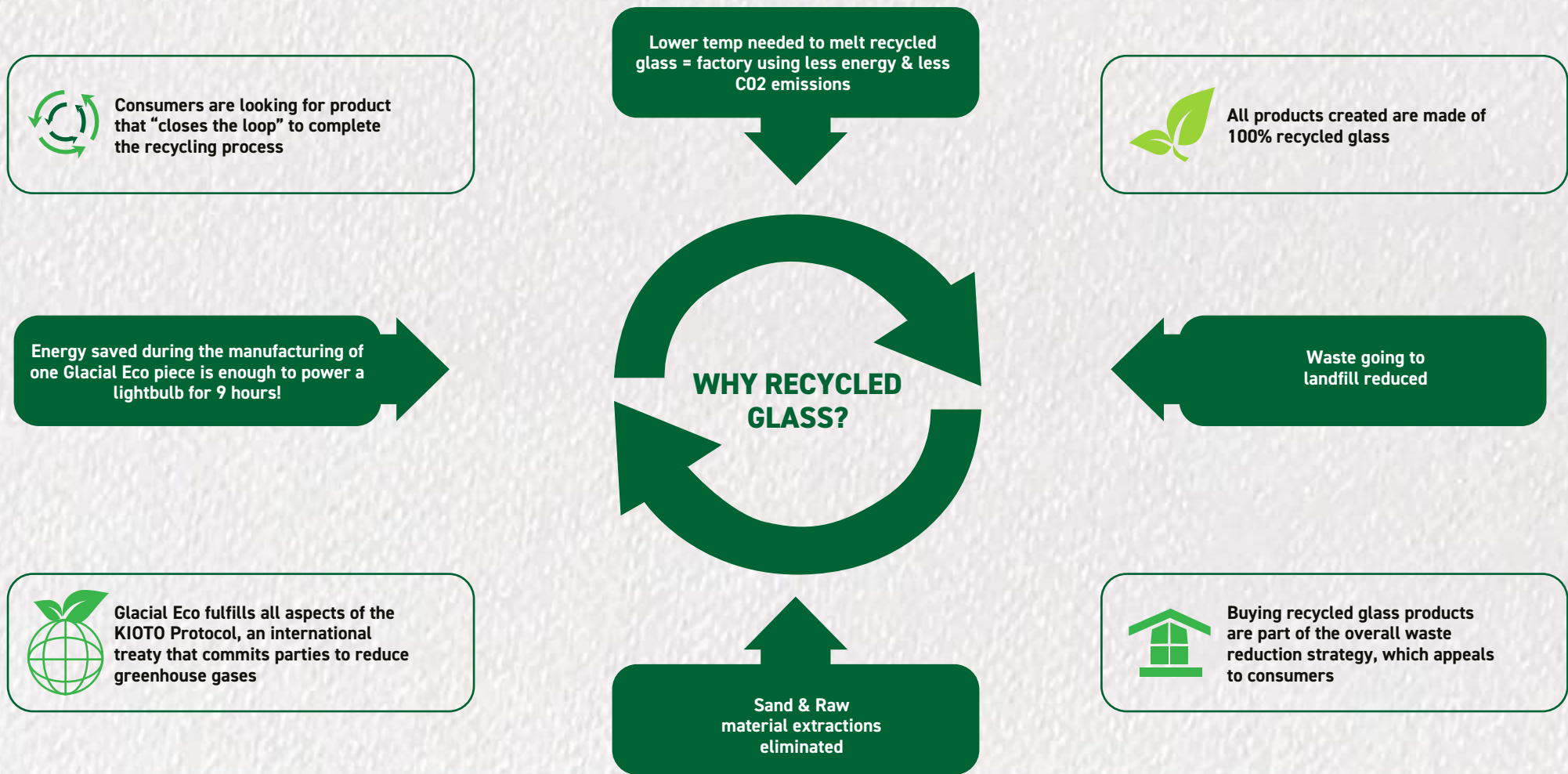

Did you Know?

The saved energy in recycling three bottles is enough to charge a smartphone battery for a year, maintain a low consumption light bulb on for nine days and it is equivalent to the energy needed for three cycles of a washing machine.



Code	Description	Case Qty.
CG328	Carafe, 1Ltr	6
CG314	Tumbler, 22cl	6
CG315	Tumbler, 27.5cl	6
CG313	Tumbler, 40cl	6
CG312	Tumbler, 50cl	6



Tower



Code	Description	Case Qty.
CG324	Stackable Tumbler, 30cl	6
CG325	Jug - 2.3Ltr	6



Pinewood



Code	Description	Case Qty.
CG319	Tumbler, 40cl	6
CG318	Tumbler, 45cl	6





Code	Description	Case Qty.
CG311	Tumbler, 35cl	6
CG310	Tumbler, 40cl	6
CG309	Tumbler, 43cl	6





Code	Description	Case Qty.
CG321	Garcia Tumbler, 22cl	6
CG322	Garcia Tumbler, 30cl	6
CG320	Volta Tumbler, 30cl	6



Pineapple & Tiki



Code	Description	Case Qty.
CG317	Pineapple, 38.5cl	6
CG316	Tiki, 55cl	6



Carafes & Bottles



Code	Description	Case Qty.
GC329	Greenwood Carafe, 1.3Ltr	6
GC328	Utah Carafe, 1Ltr	6
GC326	Taka Water Bottle, 1.5Ltr	6
GC327	Idro Water Bottle, 1Ltr	6





Code	Description	Case Qty.
CG330	Oil Bottle 50cl	6
CG331	Oil Bottle 35cl	6



Hot Beverage, Dessert and Tealight



Code	Description	Case Qty.
CG323	Hot Beverage 35cl	6
CG334	Odessa Dessert 40cl	6
CG333	Odessa Dessert 25cl	6
CG332	Crescent Tealight 7cm dia x 8cm(H)	12



GLACIAL



CONTENTS

STEMWARE

BAR COLLECTION

TUMBLERS

JUG COLLECTION

HOT BEVERAGE

DESSERT



GLACIAL IS CLEAN, PURE AND CRISP WITH ICE-LIKE CLARITY

The Glacial Collection is a stylish, high quality and comprehensive range of glassware designed specifically for professionals in the hospitality market and includes ranges of stemware, tumblers and barware.



STEMWARE

RILA

Style, quality and superb value for money.



01



02



03

- | | | | |
|----|--------------|------------------------------------------------------------------|-------------|
| 01 | CC394 | Wine 8¾oz, 25cl | Case Qty 24 |
| 01 | CC613 | Wine 8¾oz, 25cl lined and UKCA to 175ml | Case Qty 24 |
| 02 | CC395 | Wine 10½oz, 30cl | Case Qty 24 |
| 02 | CC614 | Wine 10½oz, 30cl lined and UKCA to 250ml | Case Qty 24 |
| 02 | CC630 | Wine 10½oz, 30cl Triple lined and UKCA to 125ml, 175ml and 250ml | Case Qty 24 |
| 03 | CC399 | Flute 6¼oz, 17cl | Case Qty 12 |
| 03 | CC871 | Flute 7oz, 21cl | Case Qty 12 |
| 03 | CC615 | Flute 6¼oz, 17cl lined and CE to 125ml | Case Qty 12 |

MAYA

A sleek and slender range of glasses designed for stylish environments.



01



02



03

- | | | | |
|----|--------------|------------------------------------------|-------------|
| 01 | CC402 | Wine 11¼oz, 32cl | Case Qty 24 |
| 01 | CC619 | Wine 11¼oz, 32cl lined and UKCA to 250ml | Case Qty 24 |
| 02 | CC401 | Wine / Water 13½oz, 38cl | Case Qty 24 |
| 03 | CC399 | Flute 6¼oz, 17cl | Case Qty 12 |
| 03 | CC871 | Flute 7oz, 21cl | Case Qty 12 |
| 03 | CC615 | Flute 6¼oz, 17cl lined and CE to 125ml | Case Qty 12 |



STEMWARE

AMARO

A modern range of matching stemware and tumblers, the angular bowl shape will enhance any table setting.



- | | | |
|----|------------------------------------------|-------------|
| 01 | CC875 Wine 13½oz, 38.5cl | Case Qty 12 |
| 02 | CC874 Wine / Water 17¼oz, 49cl | Case Qty 12 |
| 03 | CC873 Flute 6¾oz, 19cl | Case Qty 12 |
| 04 | CC861 Old Fashioned 12¼oz, 34.5cl | Case Qty 24 |
| 05 | CC860 Hiball 16¾oz, 48cl | Case Qty 24 |

BLUE RIDGE – FINE DINE

Offering the perfect balance between elegance and style, the clarity and quality of Blue Ridge range is perfect to enhance the fine dine experience.



- | | | |
|----|-----------------------------------------------------|-------------|
| 01 | CC492 Wine 9¼oz, 26cl | Case Qty 24 |
| 01 | CC620 Wine 9¼oz, 26cl lined and CE to 175ml | Case Qty 24 |
| 02 | CC493 Wine 12¾oz, 36cl | Case Qty 24 |
| 02 | CC621 Wine 12¾oz, 36cl lined and CE to 250ml | Case Qty 24 |
| 03 | CC494 Wine / Water 16¾oz, 48cl | Case Qty 24 |
| 04 | CC495 Flute 6oz, 16cl | Case Qty 24 |
| 04 | CC622 Flute 6oz, 16cl lined and CE to 125ml | Case Qty 24 |
| 05 | CC497 Hiball 12¾oz, 36cl | Case Qty 24 |
| 06 | CC496 Old Fashioned 12oz, 34cl | Case Qty 24 |



TUMBLERS

ATLAS

A comprehensive range of hiballs suitable for all types of establishment.

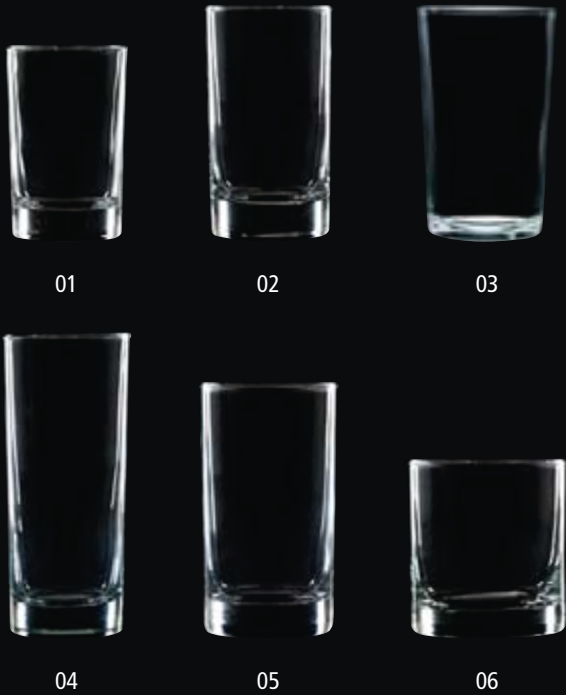

- | | | |
|----|---------------------------------------|-------------|
| 01 | CC403 Juice 6½oz, 18cl | Case Qty 36 |
| 02 | CC404 Spirit 8¾oz, 25cl | Case Qty 36 |
| 03 | CC870 Hiball 10oz, 30cl | Case Qty 24 |
| 04 | CC406 Hiball 11¾oz, 33cl | Case Qty 36 |
| 05 | CC405 Mixer 12oz, 34cl | Case Qty 36 |
| 06 | CC407 Old Fashioned 11oz, 31cl | Case Qty 36 |

ARAVALLI

A full range of heavy based tumblers suitable for any setting.



- | | | |
|----|---------------------------------------|-------------|
| 01 | CC891 Juice 7oz, 20cl | Case Qty 12 |
| 02 | CC888 Hiball 10½oz, 30cl | Case Qty 12 |
| 03 | CC890 Hiball 11¼oz, 32cl | Case Qty 12 |
| 04 | CC892 Old Fashioned 11oz, 31cl | Case Qty 12 |

SUMMIT

A classic range of American panelled tumblers in a variety of shapes and sizes.



- | | | |
|----|---------------------------------------|-------------|
| 01 | CC872 Shot 2oz, 6cl | Case Qty 24 |
| 02 | CC409 Beverage 10oz, 29cl | Case Qty 24 |
| 02 | CC631 Beverage 10oz, 29cl CE | Case Qty 24 |
| 03 | CC411 Beverage 12½oz, 35cl | Case Qty 36 |
| 04 | CC412 Beverage 16¼oz, 46cl | Case Qty 24 |
| 05 | CC410 Old Fashioned 12oz, 34cl | Case Qty 24 |

TUMBLERS

HARZ

With a conical design and heavy base the Harz range of tumblers will enhance any setting.



01



02



03



04

01 **CC881** Hiball 10oz, 30cl Case Qty 12

02 **CC880** Hiball 11½oz, 32.5cl Case Qty 12

03 **CC879** Hiball 12¼oz, 35cl Case Qty 12

04 **CC883** Old Fashioned 7¾oz, 22cl Case Qty 12

AMARO

A modern range of matching stemware and tumblers, the angular bowl shape will enhance any table setting.

Range of matching stemware available see page 2

01 **CC861** Old Fashioned 12¼oz, 34.5cl Case Qty 24

02 **CC860** Hiball 16¾oz, 48cl Case Qty 24



01

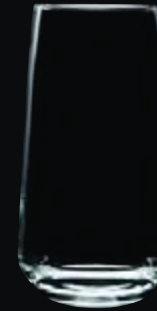

02

BLUE RIDGE – FINE DINE

Offering the perfect balance between elegance and style, the clarity and quality of Blue Ridge range is perfect to enhance the fine dine experience.

Range of matching stemware available see page 3

01 **CC496** Old Fashioned 12oz, 34cl Case Qty 24

02 **CC497** Hiball 12¾oz, 36cl Case Qty 24



01



02

SIERRA

Rounded tumblers available in either a hiball or rocks style glass.



01



02

01 **CC417** Old Fashioned 12oz, 34cl Case Qty 24

02 **CC418** Hiball 16¼oz, 46cl Case Qty 24



BAR COLLECTION



01



02



03



04



05

- | | | | |
|----|--------------|------------------------------------------|------------|
| 01 | CF335 | Champagne Coupe 7 $\frac{3}{4}$ oz, 22cl | Case Qty 6 |
| 02 | CG495 | Champagne Coupe, 34cl, 120oz | Case Qty 6 |
| 03 | CE098 | Gin Balloon 23oz, 65.5cl | Case Qty 6 |
| 04 | CE103 | Cascade 11 $\frac{1}{2}$ oz, 33.5cl | Case Qty 6 |
| 05 | CE633 | Martini 8 $\frac{1}{2}$ oz, 25cl | Case Qty 6 |



SHOT GLASSES



06



07

- | | | | |
|----|--------------|------------------------------|-------------|
| 06 | CC427 | Shot 1 $\frac{3}{4}$ oz, 5cl | Case Qty 24 |
| 07 | CC872 | Shot 2oz, 6cl | Case Qty 24 |



JUGS



08



09



10



11

- | | | | |
|----|--------------|--------------------------------------------|------------|
| 08 | CG142 | Plain Lip Jugs, 3 Pint, 1.7L | Case Qty 1 |
| 09 | CG496 | Panelled Jugs, 2.1 Pint, 1.2L | Case Qty 6 |
| 10 | CC430 | Plain Lip Jugs, 2 Pint, 1.1L | Case Qty 1 |
| 11 | CD839 | Plain Lip Jugs, 2 $\frac{1}{2}$ Pint, 1.5L | Case Qty 1 |

HOT BEVERAGE

HOT BEVERAGE - MUG



01

01 CG070 Hot Beverage - Mug 30cl

Case Qty 12



DESSERT

SUNDAE GLASS



01

01 **CC765** Sundae Glass 12oz, 36cl Case Qty 12

DESSERT DISHES



02

02 **CD837** Dessert Dish 14oz, 40cl Case Qty 12



03

03 **CD838** Dessert Dish 10½oz, 30cl Case Qty 12







PLASMA BARWARE

Plasma combines stylish and safe polycarbonate drinkware with a wide range of bar and cocktail accessories to create a comprehensive barware solution under one brand.

Serve or chill wine, mix cocktails or add ice to serve on the rocks,
Plasma can provide the perfect solution.

POLYCARBONATE DRINKWARE

ARGON TUMBLERS

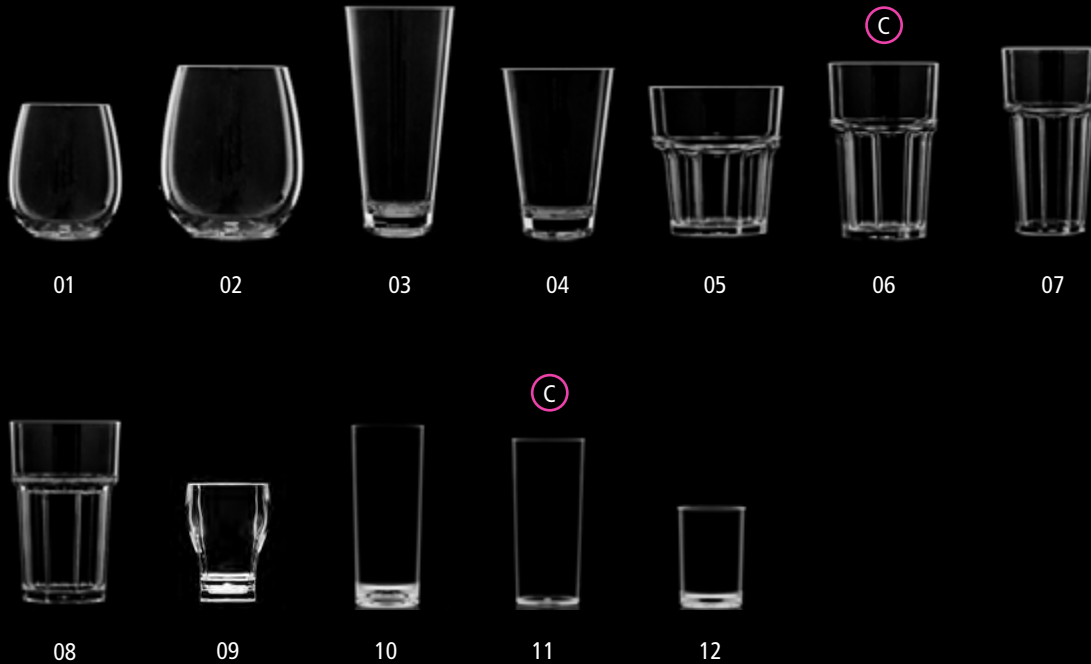

- | | | | | | |
|----|-----------------------------------------------------|-------------|----|-----------------------------------------------------|-------------|
| 01 | CB080 Ultra Stemless Wine 17oz, 50cl | Case Qty 12 | 09 | CB067 Bulb Tumbler 8oz, 25cl | Case Qty 48 |
| 02 | CB079 Ultra Stemless Wine 29oz, 85cl | Case Qty 12 | 10 | CF046 Hiball 12oz, 34cl | Case Qty 36 |
| 03 | CB066 Tall HiBall 10oz, 29cl | Case Qty 36 | 11 | CC777 Hiball 12oz, 34cl - 1/2 Pint CE Marked | Case Qty 48 |
| 04 | CB064 Tall Tumbler 12 $\frac{3}{4}$ oz, 36cl | Case Qty 36 | 12 | CF397 Hiball 6oz, 17.7cl | Case Qty 36 |
| 05 | C9151 Tumbler 9oz, 27cl | Case Qty 36 | | | |
| 06 | C9152 Tumbler 10oz, 29cl CE Marked | Case Qty 36 | | | |
| 07 | C9153 Tumbler 12oz, 35cl | Case Qty 36 | | | |
| 08 | CD650 Tumbler 14oz, 40cl | Case Qty 24 | | | |

NEON - BEER

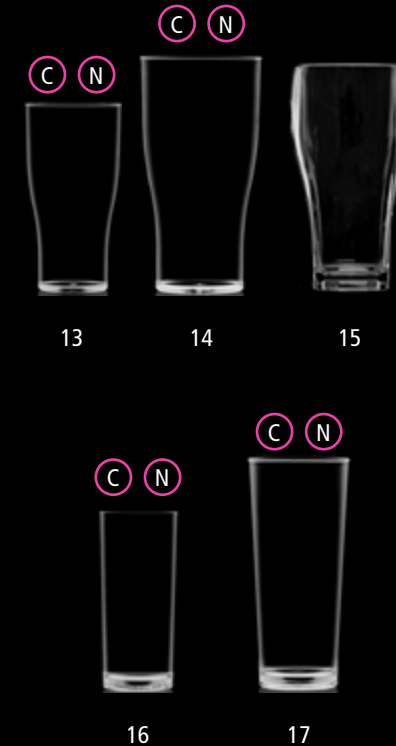

- | | | |
|----|-------------------------------------------------------|-------------|
| 13 | C7167 Neon Tulip Nucleated 1/2 Pint CE Marked | Case Qty 48 |
| 14 | C7166 Neon Tulip Nucleated 1 Pint CE Marked | Case Qty 48 |
| 15 | CB069 Neon Bulb Pint Glass 20oz, 58cl | Case Qty 48 |
| 16 | CF394 Hiball Nucleated 10oz CE Marked | Case Qty 36 |
| 17 | CF393 Neon Straight Nucleated 1 Pint CE Marked | Case Qty 24 |



C = CE Marked **N** = Nucleated

POLYCARBONATE DRINKWARE

XENON - COCKTAIL/PARTY



01

01 **CF370** Gin Balloon 25.7oz, 76cl

Case Qty 24



KRYPTON WINE



02



03



04



05



06



07



08



09



10



11

02 **CB072** Ultra Angled Champagne 6oz, 15cl Case Qty 12

03 **CB073** Ultra Angled Wine 13oz, 36cl Case Qty 12

04 **CB075** Ultra Angled Wine 20oz, 58cl Case Qty 12

05 **CB081** Ultra Champagne Flute 6oz, 15cl Case Qty 12

06 **CB078** Ultra Wine 11½oz, 34cl Case Qty 12

07 **CB077** Ultra Wine 15oz, 44cl Case Qty 12

08 **CD649** Metro Champagne Flute 6.6oz, 18.7cl Case Qty 12

09 **CD005** Metro Champagne Flute 6.6oz, 18.7cl Case Qty 12
CE Marked 17.5cl

10 **C9255** Metro Wine 9oz, 27cl Case Qty 12

11 **C9256** Metro Wine 12oz, 35cl Case Qty 12



C = CE Marked

N = Nucleated

BAR TOOLS



01



02



03



04



05



06



07



08



09



10



11



12

13

14



15



16



- 01 **D2146** Waiters' Friends Three Part - Stainless Steel Case Qty 1
- 02 **D2647** Waiters Friend Pull Tap Model - Black Case Qty 1
- 03 **D2646** Waiters Friend Three part - Coloured Handle (Colour May Vary) Case Qty 1
- 04 **D1078** Bar Blade Bottle Opener, 17.8cm - Stainless steel Case Qty 1
- 05 **D2122** Oval Cocktail Strainer Julep - Stainless Steel Case Qty 1
- 06 **D1486** Cocktail Strainer Four Prong - Stainless Steel Case Qty 1
- 07 **D2127** Three Claw Type Ice Cube Tongs, 18cm - Stainless steel Case Qty 1
- 08 **D2147** Serrated Ice Cube Tongs, 18cm - Stainless steel Case Qty 1

- 09 **D2576** Champagne Bottle Resealer - Chrome Case Qty 1
- 10 **DC902** Muddler, 20.3cm - Stainless Steel, Black Head Case Qty 1
- 11 **D2162** Mixing Spoon 28cm, 11" - Stainless Steel Case Qty 1
- 12 **D2669** Ice Scoop 170 gram, 18cm Overall - Aluminium* Case Qty 1
- 13 **D2670** Ice Scoop 340 gram, 23cm Overall - Aluminium* Case Qty 1
- 14 **D2671** Ice Scoop 680 gram, 27cm Overall - Aluminium* Case Qty 1
- 15 **D2673** Ice Scoop 4" Blade, 24cm Overall - Stainless Steel Case Qty 1
- 16 **SP0169** Spare Sponge for D2637 Case Qty 1

BAR TRAY

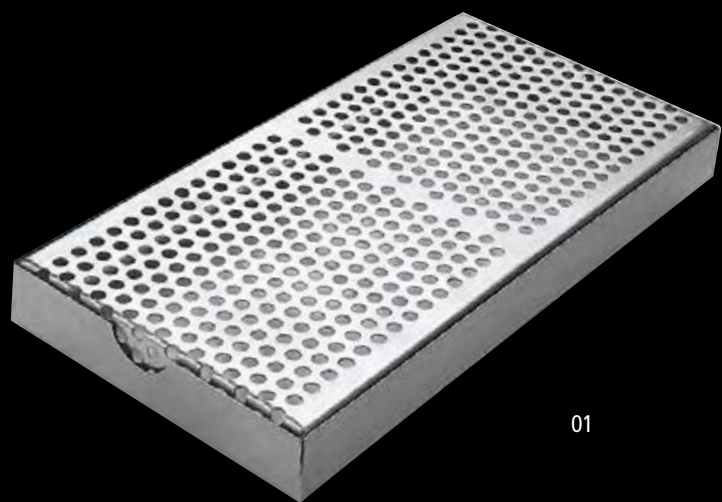

01

BAR TRAY

01 D2624 Drainer / Drip Tray, 30 x 15cm - Stainless Steel

Case Qty 1



POURERS & SHAKERS



POURERS & SHAKERS

01 **D2661*** 'Freeflow' Bottle Pourer - High Speed Pourer Chrome with Polycork (Not suitable for acidic liquors) Case Qty 1

02 **D2663*** 'Freeflow' Medium Slow Bottle Pourer - Stainless Steel with Polycork Case Qty 1

*Please note, these pourers are not CE stamped.

03 **DJ984** Tapour (Modified) - Stainless Steel Case Qty 1

04 **D1474** Boston Style Shaker - Cocktail Base 28oz, 79cl - Stainless Steel Case Qty 1

05 **CE124** Boston Style Shaker - Mixing Glass 16oz, 46cl - to fit Base D1474 Case Qty 1

06 **D2137** Cocktail Shaker 18oz - Stainless Steel Case Qty 1

06 **D2140** Cocktail Shaker 30oz - Stainless Steel Case Qty 1

WINE COOLERS, ICE BUCKETS & ICE TUBS



01



02



03



04



05



WINE COOLERS, ICE BUCKETS & ICE TUBS

- | | | | |
|----|--------------|-------------------------------------------------------------------------------|------------|
| 01 | D2665 | Wine Cooler With Ring Handles 20 x 19cm dia - Stainless Steel | Case Qty 1 |
| 02 | D1070 | Double Walled Cooler 20 x 12cm dia - Polished Stainless Steel | Case Qty 1 |
| 03 | D2161 | Wine Cooler, 19 x 21.5cm dia - Stainless Steel | Case Qty 1 |
| 04 | D2132 | Wine Cooler with Ring Handles - Aluminium 20 x 21cm dia (Not Dishwasher Safe) | Case Qty 1 |
| 05 | D3024 | Ice Tub 28cm dia x 18cm - Polished Aluminium | Case Qty 1 |

TRAYS & STRAWS

Pro-Grip Anti-Slip Trays

- Anti-slip surface resists glassware slippage even when wet
- Bonded liner covers entire tray surface and side walls for extra grip
- Dishwasher safe



An exceptionally durable range of black anti-slip trays combining quality with outstanding value.

- | | | | |
|----|--------------|---------------------------------|------------|
| 01 | D3063 | Anti-Slip Tray Round 35.5cm dia | Case Qty 1 |
| 02 | D3064 | Anti-Slip Tray Round 40.5cm dia | Case Qty 1 |
| 03 | D3062 | Anti-Slip Tray Oval 68 x 56cm | Case Qty 1 |



PAPER STRAWS

- | | | | |
|----|--------------|--------------------------------------|-------------|
| 04 | DI793 | Paper Black Stripe Straws, 20cm, 6mm | Pack of 250 |
| 05 | DL302 | Paper Plain Black Straws, 14cm, 6mm | Pack of 250 |
| 06 | DI794 | Paper Plain Black Straws, 20cm, 6mm | Pack of 250 |
| 07 | DI197 | Paper Green Stripe Straws, 20cm, 6mm | Pack of 250 |
| 08 | DI331 | Paper Blue Stripe Straws, 20cm, 6mm | Pack of 250 |
| 09 | DI780 | Paper Navy Stripe Straws, 20cm, 6mm | Pack of 250 |
| 10 | DI328 | Paper Red Stripe Straws, 20cm, 6mm | Pack of 250 |
| 11 | DI795 | Paper Plain White Straws, 20cm, 6mm | Pack of 250 |

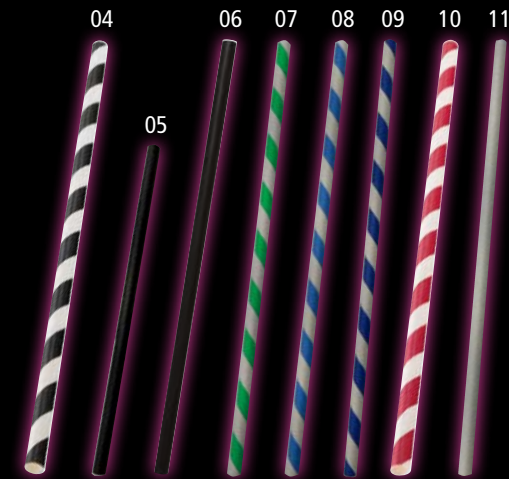

STAINLESS STEEL STRAW

- | | | | |
|----|--------------|-------------------------------|-----------|
| 12 | DM756 | Stainless Steel Straw, 21.5cm | Pack of 6 |
|----|--------------|-------------------------------|-----------|

BUFFET

BUFFET



136



150



163



174



PODIUM

ELEVATING BUFFET PRESENTATION



WELCOME

ELEVATING BUFFET PRESENTATION

Welcome to our NEW Buffet brand - PODIUM

Created in collaboration with experts, PODIUM is a modular display solution that provides more flexibility than ever when it comes to creating beautiful displays.

PODIUM is a range of high quality products manufactured in the UK from Sustainable FSC Certified European Prime Oak.

Within a demanding hospitality and catering environment, creating eye catching buffet displays can be especially daunting. PODIUM being a modular display solution comprising; Trolleys, Trays, Box Risers, Bread Bins, Tea Chests and Buffet Trolleys makes it an easy process to build your buffet display. The system of modular interchangeable stackable components offers great versatility in tailoring your displays making it easy to switch from a breakfast presentation with breads and pastries, to a hot display of main courses for a lunch service.

These intelligently designed PODIUM products enable operators in the catering and hospitality industry to optimise food and beverage presentations; by providing easy display solutions allowing for multiple configuration options.

PODIUM is a perfectly tailored solution; from tea-coffee stations or pop-up island bars to room service. Whether used in board rooms, conference facilities, hotels, restaurants or even spas, our new PODIUM range offers great flexibility to present food and drink displays, elevating your buffet presentation.

The display possibilities are endless with Podium.



PODIUM



CONTENTS



Trolleys	139
Boxes	141
Box Inserts	143
Box Concepts	144
Butler Trays	145
Bread Bins & Tea Chests	146
Buffet Trolley	147
Sizing Guide for Podium Trolleys & Accessories	148



TROLLEYS

Podium trolleys offer multiple configuration options. The presentation surfaces can be extended to tailor your F & B presentation needs. You can maximise the surface utility with additional accessories, including inserts, boxes, tea chests and trays. With shelves and a folding surface design, each trolley offers an adaptable display solution for both single - and double-sided service. The trolleys come in four beautiful colours: Black, Grey, Dark Brown and Natural.



Please note that the Podium Boxes, Inserts and Trays are designed in a way to slot in perfectly to these trolleys. The size guide will help you in making decisions: See Page 148

Podium Standard Trolleys

Natural	Grey	Brown	Black	Dimensions
DN408NA	DN408GY	DN408BR	DN408BK	Standard - 798 x 558 x 855mm
DN409NA	DN409GY	DN409BR	DN409BK	Long - 1012 x 558 x 855mm



Please note that the Podium Boxes, Inserts and Trays are designed in a way to slot in perfectly to these trolleys. The size guide will help you in making decisions: See Page 148

Podium Drop Leaf Trolleys

Natural	Grey	Brown	Black	Dimensions
DN410NA	DN410GY	DN410BR	DN410BK	Standard - 805/1460 x 558 x 855mm
DN411NA	DN411GY	DN411BR	DN411BK	Long - 1012 x 558 x 855mm

TROLLEYS



Please note that the Podium Boxes, Inserts and Trays are designed in a way to slot in perfectly to these trolleys. The size guide will help you in making decisions: See Page 148



Podium Island Trolleys

Natural	Grey	Brown	Black	Dimensions
DN412NA	DN412GY	DN412BR	DN412BK	Standard - 830/1465 x 595/1225 x 855mm
DN413NA	DN413GY	DN413BR	DN413BK	Long - 1044/1678 x 595/1225 x 855mm

BOXES



Rib Box B1/1 - 636 x 398mm

Natural	Grey	Brown	Black	Depth
DN415NA	DN415GY	DN415BR	DN415BK	120mm
DN416NA	DN416GY	DN416BR	DN416BK	80mm
DN417NA	DN417GY	DN417BR	DN417BK	40mm

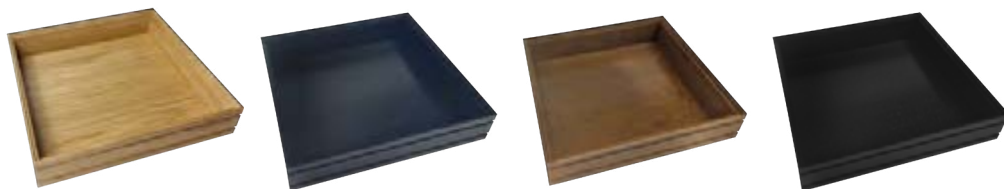

Rib Box B2/3 - 424 x 398mm

Natural	Grey	Brown	Black	Depth
DN418NA	DN418GY	DN418BR	DN418BK	120mm
DN419NA	DN419GY	DN419BR	DN419BK	80mm
DN421NA	DN421GY	DN421BR	DN421BK	40mm

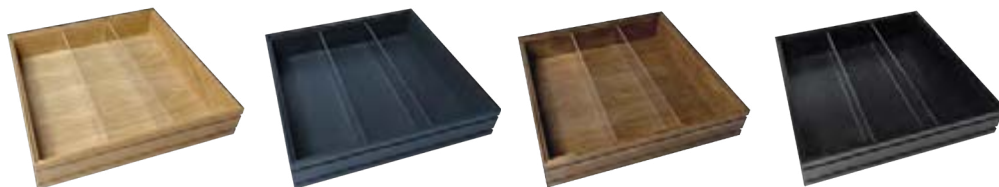

Rib Box B2/3 With 2 Dividers - 424 x 398mm

Natural	Grey	Brown	Black	Depth
DN420NA	DN420GY	DN420BR	DN420BK	80mm

The Podium boxes are designed to offer you greater flexibility with your display options and work seamlessly with the trolleys. They can be used as cutlery boxes or to display other essential items. The boxes also come in Black, Grey, Dark Brown and Natural to coordinate to with the trolley colour of your choice.



Please note that the Podium boxes are designed in a way to slot in perfectly to the Podium trolleys. The size guide will help you in making decisions: See Page 148

BOXES

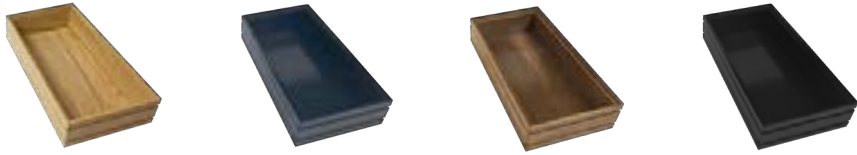

Rib Box B1/3 - 398 x 212mm

Natural	Grey	Brown	Black	Depth
DN422NA	DN422GY	DN422BR	DN422BK	120mm
DN423NA	DN423GY	DN423BR	DN423BK	80mm
DN425NA	DN425GY	DN425BR	DN425BK	40mm

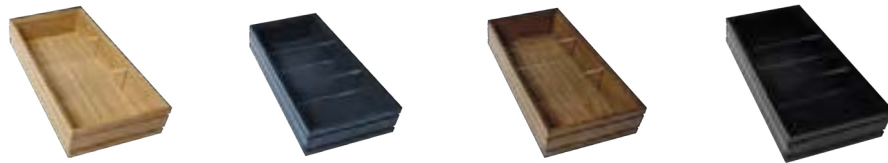
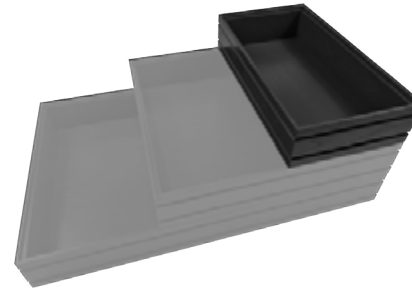

Rib Box B1/3 With 2 Dividers - 398 x 212mm

Natural	Grey	Brown	Black	Depth
DN424NA	DN424GY	DN424BR	DN424BK	80mm
DN426NA	DN426GY	DN426BR	DN426BK	40mm

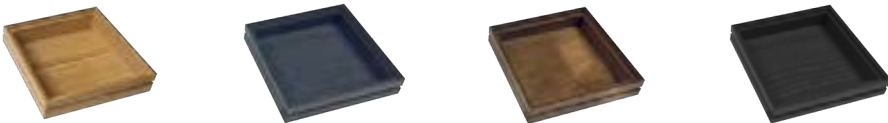

Rib Box B1/6 - 212 x 199mm

Natural	Grey	Brown	Black	Depth
DN427NA	DN427GY	DN427BR	DN427BK	120mm
DN428NA	DN428GY	DN428BR	DN428BK	80mm
DN429NA	DN429GY	DN429BR	DN429BK	40mm



BOX INSERTS

The Podium box inserts are intelligently designed to allow a myriad of variations and combinations to your unique display needs. Inserts can be added or removed based on how you wish to tailor your display and can also be used for single serves.

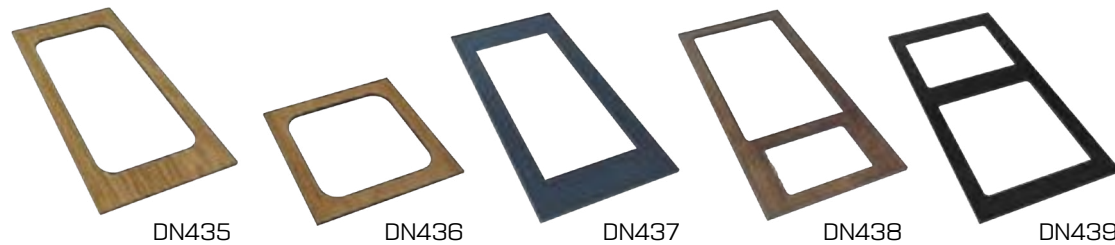

Inserts

Natural	Grey	Brown	Black	Compatibility
DN435NA	DN435GY	DN435BR	DN435BK	Insert B1/3 to GN1/3
DN436NA	DN436GY	DN436BR	DN436BK	B1/6 to GN1/6
DN437NA	DN437GY	DN437BR	DN437BK	B1/3 to GN1/3 Platter
DN438NA	DN438GY	DN438BR	DN438BK	B1/3 to fit DF806 + DF809
DN439NA	DN439GY	DN439BR	DN439BK	B1/3 to fit DF807 + DF808



Please note: Select the appropriate depth box; Crocs require 120mm deep boxes, 65mm GN's require 80mm boxes for example

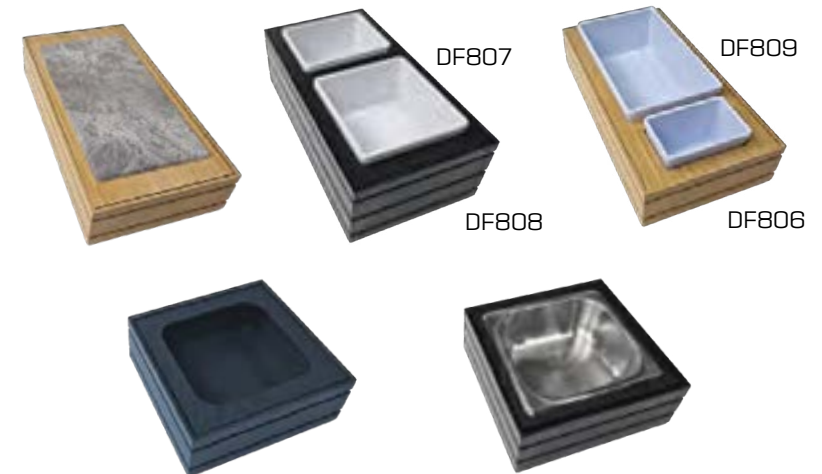

Our Mirage Crocs will fit in beautifully with the Podium inserts. (Available in various colours; White, Black, Grey Speckle) To see all Mirage crocs sizes, pls visit www.lockhart.co.uk/mirage

CONCEPTS

Podium Box Concepts

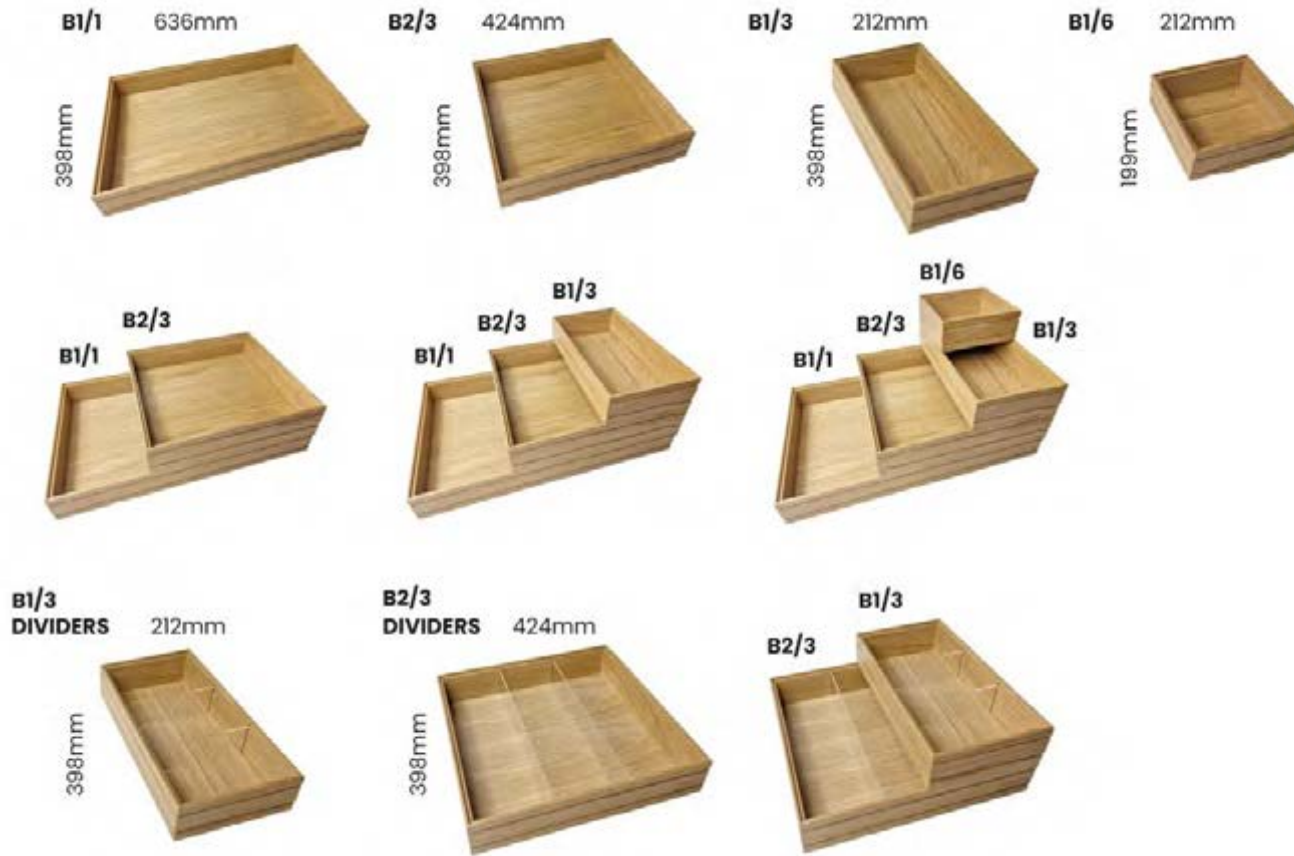

Available in 40mm, 80mm and 120mm depths and 4 colours; Natural, Grey, Dark Brown and Black.

BUTLER TRAYS

Podium Butler Trays are perfect for room service. Integrating with the Podium range of trolleys they nest neatly into the trolley shelves for secure transport. Podium Butler trays are also stackable enabling multi service when stacking 80mm deep trays.



Rib Handle Tray 2/3 - 424 x 398mm

Natural	Grey	Brown	Black	Depth
DN433NA	DN433GY	DN433BR	DN433BK	40mm
DN432NA	DN432GY	DN432BR	DN432BK	80mm



Rib Handle Tray 1/1 - 636 x 398mm

Natural	Grey	Brown	Black	Depth
DN431NA	DN431GY	DN431BR	DN431BK	40mm
DN430NA	DN430GY	DN430BR	DN430BK	80mm



Rib Handle Usher Tray 1/1 - 636 x 398mm

Natural	Grey	Brown	Black	Depth
DN434NA	DN434GY	DN434BR	DN434BK	80mm

BREAD BIN & TEA CHEST

The Podium bread boxes are designed for the covered presentation of bread and other bakery items, to keep them hygienic and fresh, and can be slotted onto the top of the trolley.
Available in four colours - Black, Grey, Dark Brown and Natural.

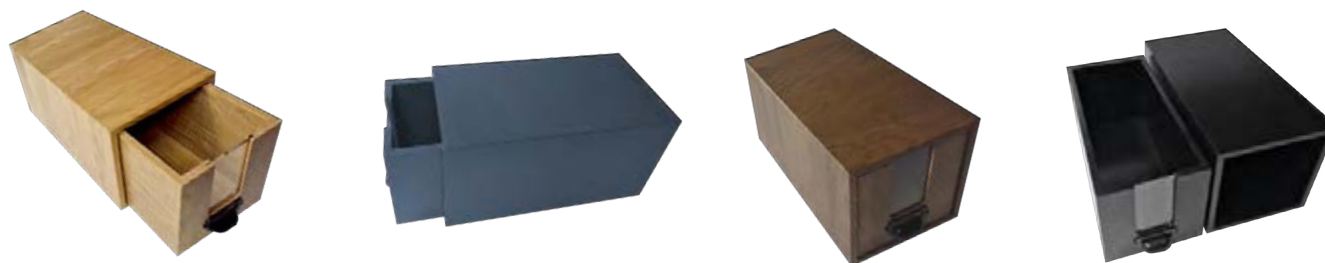

Bread Bins 1/3

Natural	Grey	Brown	Black	Dimensions
DN440NA	DN440GY	DN440BR	DN440BK	398 x 212 x 312mm



Tea Chest - 2 Drawers

Natural	Grey	Brown	Black	Dimensions
DN442NA	DN442GY	DN442BR	DN442BK	B1/3 - 398 x 212 x 244mm
DN441NA	DN441GY	DN441BR	DN441BK	B2/3 - 424 x 398 x 244mm

Designed to offer greater storage capacity and easy to replenish, the Podium tea chests are ideal for organising different flavoured tea bags. The tea chests are available in four colours to match the trolley colour of your choice.



BUFFET TROLLEY

Podium buffet trolleys are ideal for front-of-house applications. Designed so that components, such as gastronorm pans, crocs and bowls, sit securely in the trolley, they are truly customisable to your needs. The trolley sits on four sturdy swivel castors, offering smooth manoeuvring.



Shelves are reversible with a lower lip on one side, allowing for bread bin and tea chest draws to still open

Trays positions can be adjusted to horizontal or angled.



Buffet Long Trolley

Natural

Grey

Brown

Black

Dimensions

DN414NA

DN414GY

DN414BR

DN414BK

1136 x 440 x 810mm

SIZING GUIDES FOR PODIUM

Podium

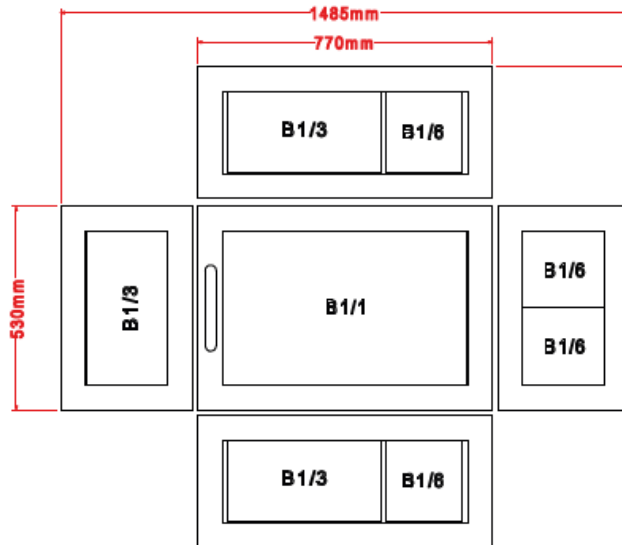

Podium Long

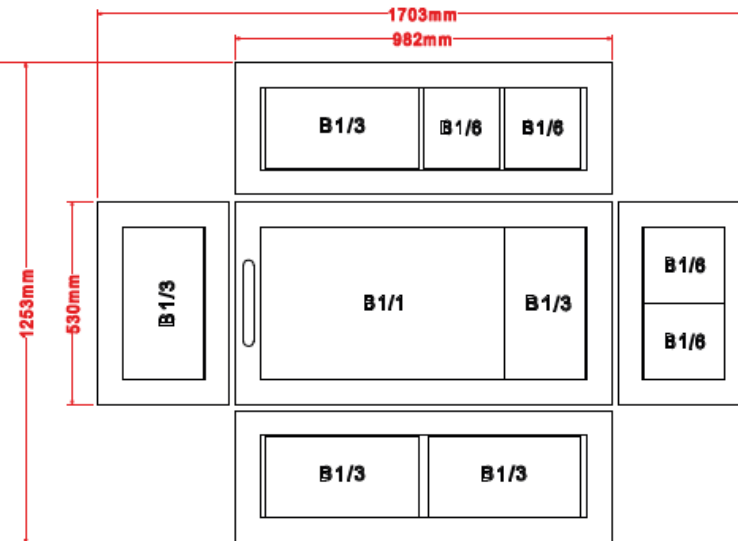

Podium Buffet Trolley

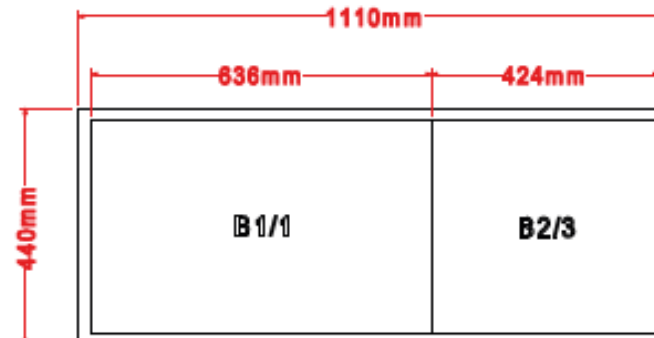
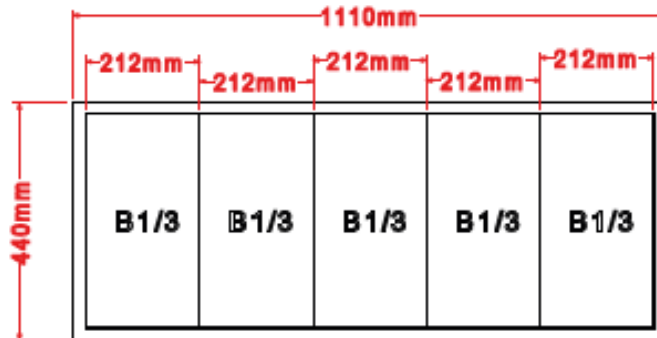

SIZING GUIDES FOR PODIUM

Podium Trolley Boxes

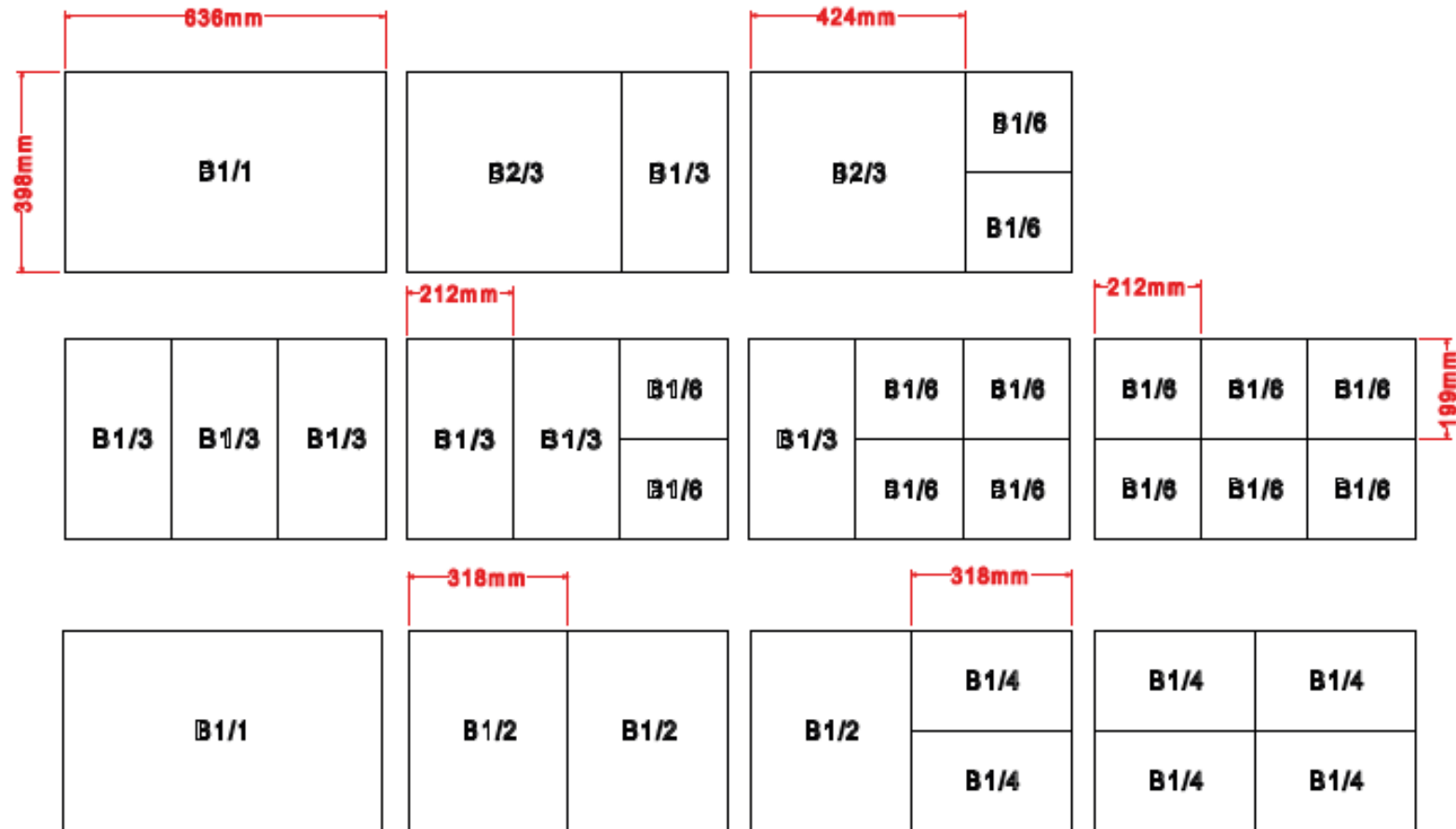

NEW

M MIDAS

THE PERFECT FINISHING TOUCH



MIDAS

THE PERFECT FINISHING TOUCH

We are excited to present our new metallic table service brand – Midas. Midas is a modern, stylish and sophisticated way of presenting side dishes to wow customers and leave a lasting impact.

Midas consists of beautiful, metallic-coloured serving & sauce cups, plates, baskets & buckets. The range comes in a number of finishes to add a touch of quirkiness to any presentation. Whether you're looking for a perfect gastropub aesthetic or a vintage industrial look, the Midas table service range is a great alternative to ceramic and offers a unique way to present food and drink that is full of personality.

With Midas, adding fun, colour and personality is easy!



CONTENTS

Ramekins & Sauce Cups	153
Serving Cups	155
Serving Wire Baskets & Buckets	157
Plates & Platters	159
Fast Food Stands	161



Products marked with this symbol
are not suitable for the dishwasher



RAMEKINS & SAUCE CUPS

The beautiful Midas ramekins & sauce cups are perfect for presenting small sides, sauces or dips to accompany food. They are a great way to add colour to your food presentation.



RAMEKINS & SAUCE CUPS



SQUARE RAMEKIN
HAMMERED ANTIQUE

DN629 2oz

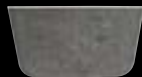

SQUARE RAMEKIN
BLACK ACID ETCHED

DN631 2oz



COLOURED - BLUE
MATT POWDER COATED

DF545 12oz
DN565 8oz
DF544 6oz
DN564 4oz
DF543 2.5oz
DF542 1.5oz



COLOURED - YELLOW
MATT POWDER COATED

DF549 12oz
DN567 8oz
DF548 6oz
DN566 4oz
DF547 2.5oz
DF546 1.5oz



COLOURED - RED
MATT POWDER COATED

DF537 12oz
DN561 8oz
DF536 6oz
DN560 4oz
DF535 2.5oz
DF534 1.5oz



COLOURED - BLACK
MATT POWDER COATED

DF541 12oz
DN563 8oz
DF540 6oz
DN562 4oz
DF539 2.5oz
DF538 1.5oz



BLACK ACID
ETCHED STAINLESS STEEL

DN573 12oz
DN572 8oz
DN571 6oz
DN570 4oz
DN569 2.5oz
DN568 1.5oz



GOLDEN HONEYCOMB
ETCHED STAINLESS STEEL

DN579 12oz
DN578 8oz
DN577 6oz
DN576 4oz
DN575 2.5oz
DN574 1.5oz



BRICK-HOUSE
STAINLESS STEEL

DN559 12oz
DN558 8oz
DN557 6oz
DN556 4oz
DI107 2.5oz
DI106 1.5oz



HAMMERED DOTS
STAINLESS STEEL

DN555 12oz
DN554 8oz
DN553 6oz
DN552 4oz
DN551 2.5oz
DN550 1.5oz



PLAIN MIRROR
STAINLESS STEEL

DE188 12oz
DN543 8oz
DN542 6oz
DC092 4oz
DF066 2.5oz
DC924 1.5oz



HAMMERED
STAINLESS STEEL

DG393 4oz
DF837 2.5oz
DG392 1.5oz



ANTIQUE
STAINLESS STEEL

DN549 12oz
DN548 8oz
DN547 6oz
DN546 4oz
DN545 2.5oz
DN544 1.5oz

SERVING CUPS

The stainless steel Midas pots provide the perfect gastropub look and can be used alone or with greaseproof paper. These cups are great for serving drinks, appetisers and sides such as fries and onion rings. With a choice of plain, hammered or a beautiful engraved finish, you can be sure of adding style to your food and drinks presentation with these serving pots.



SERVING CUPS



CHIP CUPS 3.5"



BLACK ACID
ETCHED STAINLESS STEEL

DN581 13.75oz



GOLDEN HONEYCOMB
ETCHED STAINLESS STEEL

DN582 13.75oz



ANTIQUE
STAINLESS STEEL

DN580 13.75oz



BRICK-HOUSE
STAINLESS STEEL

DI112 13.75oz

ANGLED CHIP CUPS 3.5"



BLACK ACID
ETCHED STAINLESS STEEL

DN585 13.75oz



ANTIQUE
STAINLESS STEEL

DN584 13.75oz



HAMMERED
POLISHED STAINLESS STEEL

DN583 13.75oz



BRICK-HOUSE
STAINLESS STEEL

DI110 13.75oz



HAMMERED BLACK ACID
ETCHED STAINLESS STEEL

DN586 13.75oz

MINI MILK CHURN



PLAIN MIRROR
STAINLESS STEEL

DG926 5oz
DG925 2.5oz



SERVING WIRE BASKETS & BUCKETS

The Midas wire baskets are a great way to serve sharing dishes or can be used for buffet displays. Baskets can also be used as a part of serving main dishes or in counter displays.



SERVING WIRE BASKETS & BUCKETS



WIRE BASKETS



GRID BASKET - BLACK
33 X 15 X 6CM

DN633 Large



GRID BASKET - BLACK
23 X 15 X 6CM

DN632 Small



BASKETS & BUCKETS



ROUND TUB
16 X 6CM

- DN602 Copper**
- DN603 Black**
- DN604 Brass**
- DN605 Silver**



SERVING BUCKET
11 X 8CM

- DN606 Copper**
- DN607 Black**
- DN608 Brass**
- DN609 Silver**



OVAL BOAT TUB
17 X 8 X 8CM

- DN610 Copper**
- DN611 Black**
- DN612 Brass**
- DN613 Silver**



OVAL ROASTING PAN
19 X 15 X 4CM

- DN614 Copper**
- DN615 Black**
- DN616 Brass**
- DN617 Silver**



PLATES & PLATTERS

The Midas stainless steel plates and platters will bring a quirky industrial look to your tabletops and are a great way to present food.



PLATES & PLATTERS



COUPE PLATES



BLACK PVD COATED
ETCHED STAINLESS STEEL

- DN595 26cm
- DN594 24cm
- DN593 19cm
- DN592 16cm



ANTIQUE
STAINLESS STEEL

- DN591 26cm
- DN590 24cm
- DN589 19cm
- DN588 16cm



SERVING PLATES



HAMMERED SQUARE PLATE
STAINLESS STEEL

- DN627 31 x 15cm
- DN626 28 x 18cm
- DN625 26 x 12cm
- DN628 21 x 21cm
- DN624 18 x 10cm

HERITAGE TRAY
ANTIQUE FINISH

- DN597 34 x 20cm
- DN596 30 x 18cm



FAST FOOD STANDS

Perfectly suited to a wide range of popular cuisines, the stainless steel Midas stands have an attractive industrial look. From hot dogs to tacos, these stands will create a unique way to present your fast food.



FAST FOOD STANDS

SOLID STAINLESS STEEL



TACO HOLDER - SLIM
STAINLESS STEEL

- DN621 4/5 Slot - 28 x 7 x 5cm
- DN620 2/3 Slot - 18.5 x 7 x 5cm



TACO HOLDER - WIDE
STAINLESS STEEL

- DN619 4/5 Slot - 28 x 10 x 5cm
- DN618 2/3 Slot - 18.5 x 10 x 5cm



WIREFRAME S/STEEL



TACO HOLDER - WIRE
STAINLESS STEEL

- DN623 3/4 Slot - 20 x 7 x 4cm
- DN622 1/2 Slot - 13.5 x 7 x 4cm



MENU CARD HOLDERS

MATT BLACK
STAINLESS STEEL

- DN598 4 x 2 x 2cm
- DN600 6 x 2.5 x 2.5cm

MATT BRUSHED
STAINLESS STEEL

- DN599 4 x 2 x 2cm
- DN601 6 x 2.5 x 2.5cm



rafters



rafters



WOOD THAT WORKS

Bring texture and warmth to displays with Rafters collection of innovative and flexible wooden presentation pieces. From Build GN modular systems to Grip chunky handled boards, Elevate risers to Fusion copper boards - creativity has never been so easy. Beautiful, durable, flexible - Rafters. It's wood that works.



ELEVATE

ADD NEW HEIGHTS TO CREATE MULTI-LEVEL DISPLAYS WITH ELEVATE - A VERSATILE RANGE OF BLOCKS AND RISERS



NEW

Ladders

- 01 **DM681** 30 x 50 x 50cm (H) - Light Case Qty 1
- 02 **DM682** 30 x 50 x 50cm (H) - Dark Case Qty 1

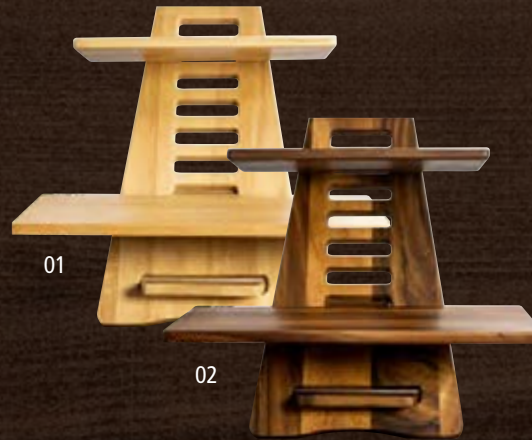

Nesting Blocks

- 03 **DI021** Large - 29 x 20 x 10.5cm Case Qty 1
- 04 **DI022** Small - 23 x 20 x 7cm Case Qty 1



XYZ Box Risers

- 05 **DI014** 15 x 15 x 15cm Case Qty 1
- 06 **DI016** 38 x 12 x 10cm Case Qty 1
- 07 **DI017** 30 x 20 x 10cm Case Qty 1

Hollow Construction
Our versatile XYZ Box Risers are hollow so use them to store, display or elevate

Mesh Collapsible Risers

- 08 **DI018** Small - 11.5 x 11.5 x 10cm Case Qty 1
- 09 **DI019** Medium - 17 x 17 x 15cm Case Qty 1
- 10 **DI020** Large - 22.5 x 22.5 x 20cm Case Qty 1



Solid Display Blocks

- 11 **DF995** 15 x 15 x 10cm Case Qty 1
- 12 **DF996** 15 x 15 x 15cm Case Qty 1



Crate

- 13 **DF994** 18 x 16 x 15cm Case Qty 1



ELEVATE

Natural Shaped Riser & Board

14 **DK467** 36.5 x 28 x 9.3cm Case Qty 1

15 **DK468** 36.5 x 28 x 4cm Case Qty 1



14



15



19

18

Serving Blocks

18 **DJ808** Small - 28.5 x 20 x 7.9cm Case Qty 1

19 **DJ809** Large - 45.6 x 20 x 7.9cm Case Qty 1



16

17

Round Cake Stands

16 **DJ806** 24.8 x 14cm Case Qty 1

17 **DJ807** 30.5 x 14cm Case Qty 1

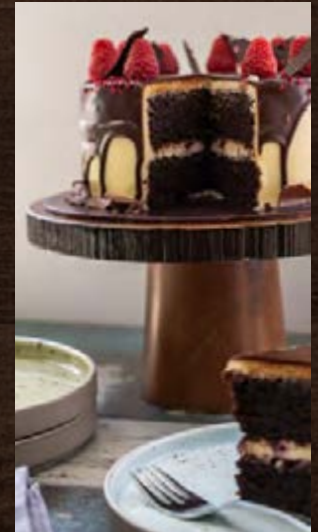

20

Buffet Bowl

20 **DI026** Buffet Bowl / Riser - 30 x 10cm, 5.5L Case Qty 1

Platter/Lid **DI027**
fits bowl **DI026**

FLOAT

RAFTERS FLOAT IS A RANGE OF CRATES, TRAYS AND PLATTERS TO ADD HEIGHT, PRESENT FOOD AND MAKE ANY DISPLAY COMPLETE



Teak Boards

- | | | | |
|----|-------|---------------|------------|
| 01 | DK269 | 60 x 50 x 5cm | Case Qty 1 |
| 02 | DK270 | 61 x 45 x 5cm | Case Qty 1 |
| 03 | DK267 | 46 x 30 x 5cm | Case Qty 1 |
| 04 | DK268 | 40 x 30 x 5cm | Case Qty 1 |



Serving Boards

- | | | | |
|----|-------|------------------------------------------------|------------|
| 05 | DM172 | Oval Wooden Board With Well 27.5 x 17cm | Case Qty 1 |
| 06 | DM173 | Rectangle Wooden Board 28.5 x 17cm | Case Qty 1 |
| 07 | DM174 | Wooden Paddle Board 57 x 14 x 2cm | Case Qty 1 |
| 08 | DM175 | Wooden Rectangular Board With Groove 30 x 18cm | Case Qty 1 |



Rustic Display Trays

- | | | | |
|----|-------|--------------------------|------------|
| 09 | DI009 | Medium - 33 x 25.4 x 5cm | Case Qty 1 |
| 10 | DI010 | Large - 40 x 30 x 5cm | Case Qty 1 |
| 11 | DI011 | Small - 25 x 12 x 5cm | Case Qty 1 |
| 12 | DI012 | GN 1/1 - 53 x 32.5 x 5cm | Case Qty 1 |

FLOAT



13



14

Rustic Display Crates

13 DI007 30 x 21 x 7cm

Case Qty 1

14 DI008 42 x 33 x 7cm

Case Qty 1



Bread Board

15 DK065 Bread Board Top - 38 x 28 x 4cm Case Qty 1

16 DK066 Display Crate Base - 40 x 30 x 5cm Case Qty 1



15

16



EDGE

ADD SOME 'EDGE' TO PRESENTATION WITH A DISTINCTIVE TWIST ON TRADITION TO BRING SOMETHING TRULY DIFFERENT TO ANY DISPLAY



Presentation Boards With Bark Edge

01 DG009 20 x 30 x 2cm Case Qty 1

02 DG010 20 x 50 x 2cm Case Qty 1

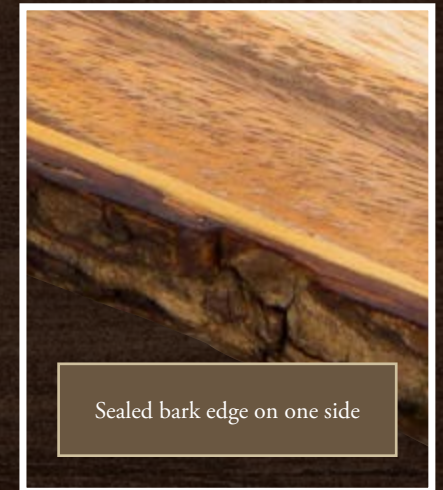
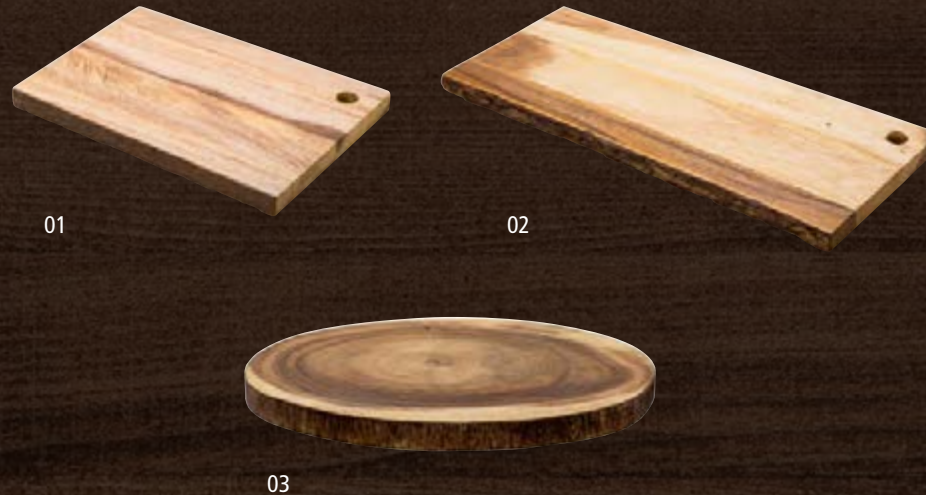

Round Display Platter

03 DJ805 32.5 x 2cm Case Qty 1



GRIP

CHUNKY GREY OR SHINY COPPER - PRESENTATION BOARDS WITH UNIQUE HANDLES TO ADD CHARM AND STYLE TO TABLE AND DISPLAY



Mango Boards with Grey Handle

- 01 **DK469** Round - 43.2 x 30.5 x 2.5cm Case Qty 1
- 02 **DK470** Rectangle - 50 x 20 x 2.5cm Case Qty 1
- 03 **DK471** Rectangle - 48.3 x 30.5 x 2.5cm Case Qty 1



Rectangle Platters with Bar Handle

- 04 **DF997** 35 x 20 x 3cm Case Qty 1
- 05 **DF998** 50 x 20 x 3cm Case Qty 1



Platters with Curved Handle

- 06 **DG002** Rectangle - 20 x 30 x 2cm Case Qty 1
- 07 **DG003** Rectangle - 20 x 40 x 2cm Case Qty 1
- 08 **DG004** Rectangle - 20 x 50 x 2cm Case Qty 1
- 09 **DF999** Round Dia - 30 x 2cm Case Qty 1
- 10 **DG001** Round Dia - 40 x 2cm Case Qty 1

FUSION

STYLISH COPPER CORNERS CONTRASTED WITH THE DARK ACACIA WOOD ADD A UNIQUE TOUCH TO ANY DISPLAY



G/N Footed Boards With Copper Corners

- | | | | |
|----|-------|--------------------------|------------|
| 01 | DH840 | 1/1 GN - 35 x 55 x 8cm | Case Qty 1 |
| 02 | DH841 | 1/2 GN - 28 x 34.5 x 8cm | Case Qty 1 |
| 03 | DH842 | 1/3 GN - 19 x 34 x 8cm | Case Qty 1 |
| 04 | DH844 | 2/3 GN - 32 x 35.5 x 8cm | Case Qty 1 |
| 05 | DH843 | 2/4 GN - 18 x 55 x 8cm | Case Qty 1 |



01



02



03



04



05

BUILD

CREATE UNIQUE AND VERSATILE DISPLAYS USING DIFFERENT COMBINATIONS OF RAFTERS BUILD PIECES ALONGSIDE CREME GALERIE, MIRAGE STRATA PLATTERS OR RAFTERS FUSION BOARDS

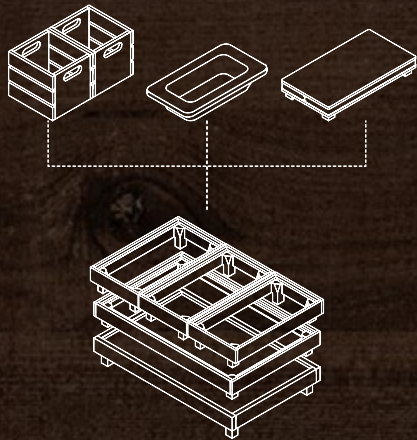

01



02



03



04



05



06

Risers & Boards

Please note that you will need a 1/1 riser to allow full compatibility with other risers and boards.

- | | | |
|----|---------------------------------------------|------------|
| 01 | DG614 Base Unit + 1/1 GN Riser | Case Qty 1 |
| 02 | DF989 1/1 GN Riser - 35 x 55 x 8cm | Case Qty 1 |
| 03 | DF990 1/2 GN Riser - 28 x 34.5 x 8cm | Case Qty 1 |
| 04 | DF991 1/3 GN Riser - 19 x 34 x 8cm | Case Qty 1 |
| 05 | DF993 2/3 GN Riser - 32 x 35.5 x 8cm | Case Qty 1 |
| 06 | DF992 2/4 GN Riser - 18 x 55 x 8cm | Case Qty 1 |

HOW TO USE YOUR BUILD SYSTEM

Step 1

LAY THE FOUNDATIONS

Base unit includes a 1/1 GN Riser which is required for full integration with the rest of the Build range.

Step 2

ADD HEIGHT

The Build range offers a variety of risers in convenient GN sizes. These can be added to create different levels of display options.

Step 3

GET CREATIVE

Various display units can be positioned on top of the risers to complete your displays. These include Fusion boards, Crème Galerie Gastronom, Mirage platters and Rafters display blocks & crates.

Step 4

ENDLESS POSSIBILITIES

See below for more inspiration on how the Build system can mix and match with various components to create customised buffet displays.

1/1 GN Riser

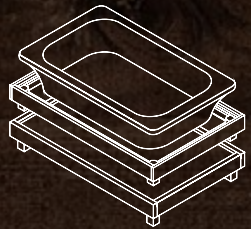

1/2 GN Riser

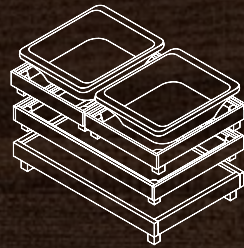

1/3 GN Riser

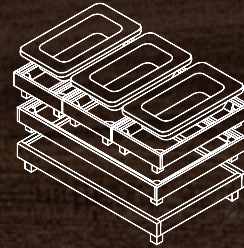

2/3 GN Riser

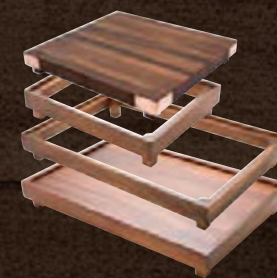
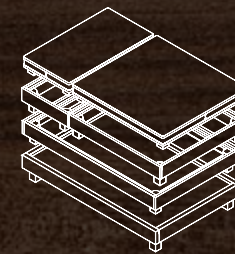

2/4 GN Riser

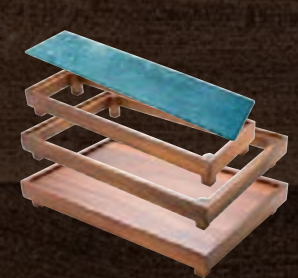
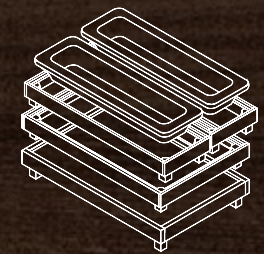

FULLY COMPATIBLE

Use Crème Galerie Gastronom dishes and platters, Mirage Gastronom platters, Fusion Copper Corner Boards and any other GN pieces to add style and variation to your display.

Crème

MIRAGE



MIRAGE



CONTENTS



MIRAGE

SEEING IS BELIEVING

Mirage is an exclusive collection of melamine products designed to provide a stylish and practical solution for food presentation and display. Offering an innovative combination of shapes, textures and vibrant colours, Mirage is the perfect choice for any buffet or counter display.

Manufactured from shatterproof 100% melamine, Mirage is highly durable with excellent levels of impact resistance and its scratch resistant surface is dishwasher safe; making it ideal for any catering or hospitality environment. This durability also makes Mirage an effective long-term investment, providing a cost effective solution without the need to compromise on style or quality.

STRATA PLATTERS

STRATA PLATTERS

Add a touch of class with the light, stylish and durable Strata platters. With its beautiful pattern and texture available in a range of sizes, Strata brings a real sense of theatre to any food presentation.

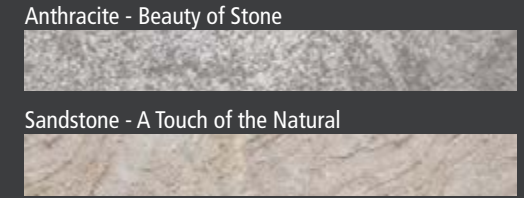
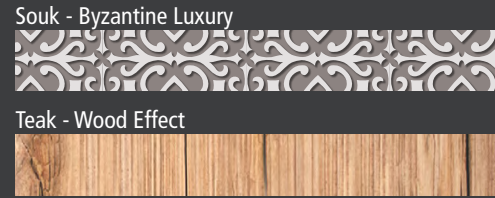





PLATTERS

- 01 **DF803** 12" x 12", 30.5 x 30.5cm
- 02 **DF804** 15" x 8", 38 x 20cm
- 03 **DF805** 20" x 10", 50 x 25cm

WHEN ORDERING

*Please quote the product code followed by the appropriate suffix for the colour required.

-  Souk - GY
-  Teak - TK
-  Anthracite - GE
-  Sandstone - SA

GN PLATTERS

- 04 **DH187** 1/1 GN - 53 x 32.5cm
- 05 **DH188** 2/4 GN - 53 x 16.2cm
- 06 **DH189** 1/3 GN - 32.5 x 17.6cm
- 07 **DH190** 1/2 GN - 32.5 x 26.5cm

WHEN ORDERING

*Please quote the product code followed by the appropriate suffix for the colour required.

-  Cobalt - BG
-  Anthracite - GE

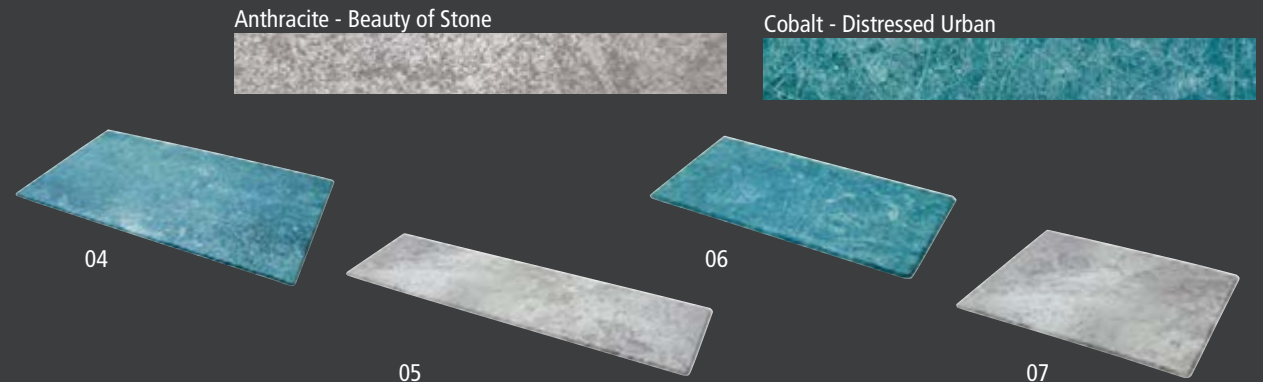

STRATA PLATTERS

STRATA GLOSS PLATTERS

New from Mirage – a collection of stunning, flat, glossy GN sized platters which create the perfect background for every presentation. Available in Satvario White Marble & Bauhaus Concrete Grey, mix and match to create a unique display. Made from lightweight, shatterproof melamine.



COMPATIBLE WITH GN COVERS

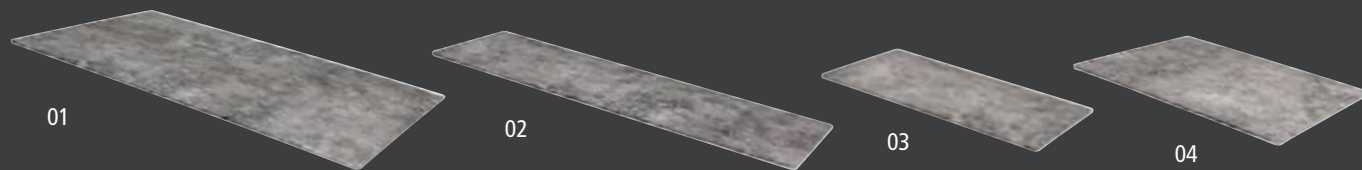

GREY

- 01 **DM270GR** Strata Bauhaus Grey Melamine Platter 1/1 GN
- 02 **DM271GR** Strata Bauhaus Grey Melamine Platter 1/2 GN
- 03 **DM272GR** Strata Bauhaus Grey Melamine Platter 1/3 GN
- 04 **DM273GR** Strata Bauhaus Grey Melamine Platter 2/4 GN

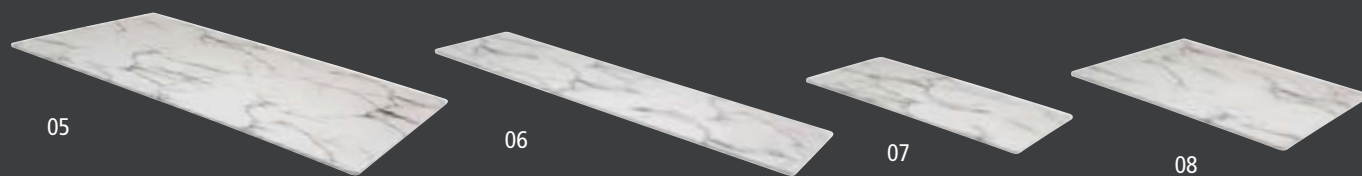

WHITE

- 05 **DM270WH** Strata Satvario White Melamine Platter 1/1 GN
- 06 **DM271WH** Strata Satvario White Melamine Platter 1/2 GN
- 07 **DM272WH** Strata Satvario White Melamine Platter 1/3 GN
- 08 **DM273WH** Strata Satvario White Melamine Platter 2/4 GN



FUSION BOWLS & PLATES

FUSION BOWLS & LIDS

These beautiful new melamine bowls, with an embossed matt exterior and smooth gloss interior, can be combined with the glossy plates to add theatre to every setting. Both available in two sizes and four stunning colours of white, black speckle, purple and blue speckle, these multi-functional pieces can be used in many ways to create a different look every time.



- 01 **B0837** Embossed Bowl 16cm - 85cl, 30oz
- 02 **B0838** Embossed Bowl 11.5cm - 30cl, 10oz
- 03 **B0839** Lid For Embossed Bowl 16cm
- 04 **B0840** Lid For Embossed Bowl 11.5cm

WHEN ORDERING
*Please quote the product code followed by the appropriate suffix for the colour required.

- White - WH
- Black Speckle - BK
- Purple - PP
- Blue Speckle - BL

FUSION BOWLS

Four individual bowls in different finishes... each one bringing a unique style to every table and display

- 05 **DG359** Ramen Bowl Matt Black 22.5 x 7.5cm - 1.45L, 51oz
- 06 **DG360** Deep Bowl Matt Black 18 x 10cm - 1.35L, 45oz



SAVANNA BOWLS

SAVANNA BOWLS

Add colour and style with this collection of large buffet bowls. Available in three sizes and three stunning colours, the glossy finish inside teamed with the textured matt finish on the outside, bring something unique to every buffet display.



01



02



03

WHEN ORDERING

*Please quote the product code followed by the appropriate suffix for the colour required.

Black Speckle - BK Purple - PP Blue Speckle - BL

01 **DK053** Savanna Buffet Bowl 33cm

02 **DK054** Savanna Buffet Bowl 39cm

03 **DK055** Savanna Buffet Bowl 44cm



PIAZZA BOWLS



PIAZZA BOWLS

In beautiful, shiny shades of both grey and sand, each with a hint of speckle, Piazza adds flair to food presentation. These large capacity versatile square bowls will add style and finesse to any display.



01



02



03



04

01 **DI649** Grey Square Bowl 19 x 19cm, 1.8L

02 **DI647** Grey Square Bowl 24.5 x 24.5cm, 4L

03 **DI650** Sand Square Bowl 19 x 19cm, 1.8L

04 **DI648** Sand Square Bowl 24.5 x 24.5cm, 4L



MARTELLO BOWLS & PLATTERS

MARTELLO BOWLS & PLATTERS

A collection of textured matt melamine pieces designed to add ultimate style to food presentation. Available in four subtle shades of white, black, grey and sand - mix and match the shapes together to elevate the display to another level.



- 01 **DI635** White Square Bowl 20 x 20cm, 2L
- 02 **DI631** White Square Bowl 24 x 24cm, 3.5L
- 03 **DI636** Black Square Bowl 20 x 20cm, 2L
- 04 **DI632** Black Square Bowl 24 x 24cm, 3.5L
- 05 **DI637** Grey Square Bowl 20 x 20cm, 2L
- 06 **DI633** Grey Square Bowl 24 x 24cm, 3.5L



- 07 **DI641** Grey Rectangle Platter 33 x 23cm
- 08 **DI645** Grey Square Platter 28 x 28cm

PICCOLO MINIATURES

PICCOLO MINIATURES

Add a little wow with Mirage Piccolo Miniatures! A collection of petite pieces with a matt finish which will complement any concept.

Available in four colours of white, black and stunning grey and sand speckle, Piccolo is the perfect choice for sides, dips, sauces, and those mini portions too.

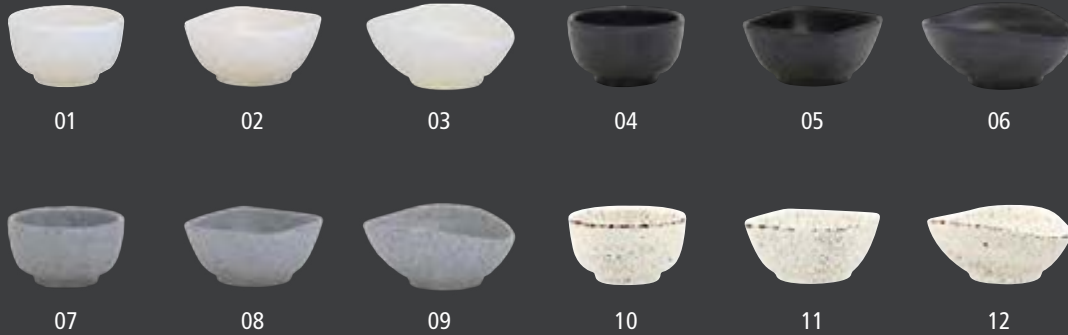

- 01 **DI657** White Mini Round Bowl 6cm, 2oz
- 02 **DI660** White Mini Square Bowl 7cm, 3.5oz
- 03 **DI663** White Mini Organic Bowl 8.5 x 7cm, 3.5oz
- 04 **DI658** Black Mini Round Bowl 6cm, 2oz
- 05 **DI661** Black Mini Square Bowl 7cm, 3.5oz
- 06 **DI664** Black Mini Organic Bowl 8.5 x 7cm, 3.5oz

- 07 **DI659** Grey Mini Round Bowl 6cm, 2oz
- 08 **DI662** Grey Mini Square Bowl 7cm, 3.5oz
- 09 **DI665** Grey Mini Organic Bowl 8.5 x 7cm, 3.5oz
- 10 **DJ650** Sand Mini Round Bowl 6cm, 2oz
- 11 **DJ649** Sand Mini Square Bowl 7cm, 3.5oz
- 12 **DJ651** Sand Mini Organic Bowl 8.5 x 7cm, 3.5oz

SMALL BOWL

A new 3oz matt white melamine bowl perfect for sides and ice cream.



13

13 **BQ529WH** White Bowl 3oz / 8 x 4cm

PICCOLO RAMEKINS

White, Black and Grey Speckle with a glossy finish – the simple choice for serving sides.



- 14 **BD950** White Ramekin 6cm, 1.5oz
- 15 **B5126** Black Ramekin 6cm, 1.5oz
- 16 **DI653** Grey Ramekin 6cm, 1.5oz
- 17 **B4824** White Ramekin 7cm, 2oz
- 18 **B1113** Black Ramekin 7cm, 2oz
- 19 **DI656** Grey Ramekin 7cm, 2oz

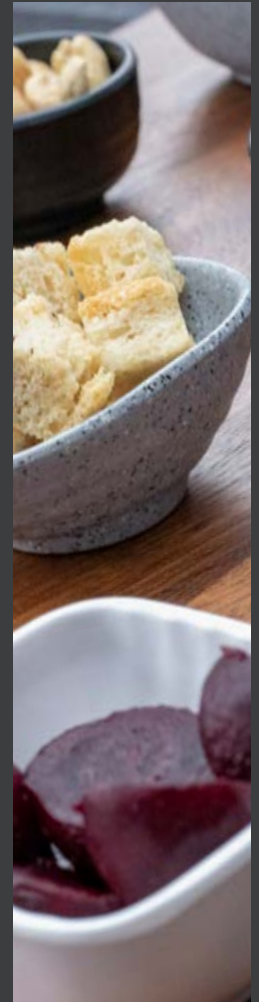

DUNE BOWLS



*Orange & Black are only available as 14.25"



01

02

03

04

DUNE BOWLS

Change the landscape of any buffet display with the Dune range of sloping buffet bowls. Available in four sizes and five vibrant colours, mix and match with other items in Mirage to create a truly stunning buffet display.

- 01 **DF800** Display Bowl - 9" x 7.5", 23 x 19cm / 0.75L, 26oz
- 02 **DF799** Display Bowl - 11" x 9", 28 x 23cm / 1.1L, 38oz
- 03 **DF798** Display Bowl - 13" x 10.8", 33 x 27.5cm / 2.0L, 70oz
- 04 **DH185** Display Bowl - 14.25" x 12", 36.5 x 30.5cm / 2.8L, 98.5oz

WHEN ORDERING

*Please quote the product code followed by the appropriate suffix for the colour required.

- White - WH
- Orchard Green - GN
- Noir Black - BK
- Fuchsia - PI
- Serville Orange - OR

OASIS BOWLS



*Orange & Black are only available as 14.25"



01

02

03

OASIS BOWLS

Add a dramatic splash of colour with these bright flare shape Oasis bowls. Available in three sizes and five striking colours, refresh the look of any buffet or counter display.

- 01 **DF802** Flared Bowl - 9.5" x 3.9", 24 x 10cm / 1.3L, 45oz
- 02 **DF801** Flared Bowl - 11" x 4.5", 28 x 11.5cm / 2.0L, 70oz
- 03 **DH186** Flared Bowl - 13.75" x 6", 35 x 15cm / 4.0L, 140.75oz

WHEN ORDERING

*Please quote the product code followed by the appropriate suffix for the colour required.

- White - WH
- Orchard Green - GN
- Noir Black - BK
- Fuchsia - PI
- Serville Orange - OR

TUNDRA



TUNDRA

Tundra brings together a selection of useful melamine pieces perfect for presenting smaller items to provide the vital finishing touches to any display, or even for presenting at the table.

CROCKS - WITH SILICONE NON-SLIP FEET



01



02



03

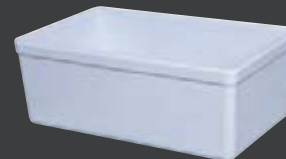

04

WHEN ORDERING

*Please quote the product code followed by the appropriate suffix for the colour required.

Polar White - WH
 Grey - GY
 Black - BK

- 01 **DF806** 13 x 8 x 10cm / 0.6L, 21oz
- 02 **DF807** 16 x 13 x 10cm / 1.5L, 53oz
- 03 **DF808** 17 x 16 x 10cm / 2L, 70oz
- 04 **DF809** 26 x 16 x 10cm / 3.2L, 112oz



05

05 **DI624** Matt Black Platter, 26.5 x 9.3cm

06

06 **D1705** Black Ashtray 4", 10cm

MELAMINE TABLEWARE

MELAMINE TABLEWARE

Find the perfect lightweight solution with this collection of melamine tableware. Shatterproof, dishwasher safe and suitable for use with hot or cold food, it is ideal for use in any demanding hospitality environment. Mix and match plain white with the bright colours of Carnival and Mosaic to create a unique background for everyday food presentation.



White



Carnival



Mosaic



- 01 **BC602W** Dinner Plate 9", 23cm
- 02 **BC603W** Salad Plate 7¼", 18.5cm
- 03 **BC600W** Side Plate 6½", 16.5cm
- 04 **BC601W** Pasta Bowl 7⅝", 19.5cm
- 05 **BC604W** Cereal Bowl 6", 15cm



- 06 **BC011** Dinner Plate 9", 23cm
- 07 **BC014** Side Plate 6¼", 16cm
- 08 **BC012** Cereal Bowl 6", 15cm



- 09 **BC031** Dinner Plate 9", 23cm
- 10 **BC034** Side Plate 6¼", 16cm
- 11 **BC032** Cereal Bowl 6", 15cm



CARE IN USE

MIRAGE MELAMINE

An exclusive collection of stylish yet practical melamine display solutions. With a combination of innovative shapes, textures and colours, Mirage is the perfect choice for any buffet or table display.



Food Safe



Made from 100% melamine



Lightweight & Shatterproof

PRODUCT USE

MIRAGE MELAMINE

- 100% Melamine
- Dimensionally Stable
- Can withstand heat up to 140°C

FOOD SAFETY

- 100% Food Safe
- Each piece tested extensively

FOOD USE

- Suitable for hot and cold food
- Designed for use at chilled and ambiente temperatures
- Not recommended for prolonged use on a hot counter
- Not suitable for use in the microwave or conventional oven



DURABILITY

- Highly Durable
- Shatterproof
- Resistant to edge chipping

CARE & CLEANING

- Do not use serrated knives on melamine products
- Do not use in conventional and microwave ovens
- Do not use harsh or abrasive cleaners, steel wool or metal scouring pads
- Do not use chlorine bleach on melamine products
- Dishwasher Safe but for a prolonged life, handwash



NEW RELAUNCHED

BRIGADE

CHEF CLOTHING



BRIGADE

CHEF CLOTHING

We are excited to relaunch our Chef's Clothing range, Brigade.

We understand the importance of the right workwear for long hours spent working in a busy kitchen or front-of-house environment. With that in mind, we have redesigned the entire range of Brigade Chef's Clothing to ensure comfort, confidence and professionalism.

Made from durable lightweight fabrics, the NEW Brigade range offers outstanding quality and consistency. Each piece is designed to project a professional image and to ensure the wearer feels confident in the performance of their workwear.

And here's the best part: the Brigade collection offers amazing value for money. So, you can choose comfort, quality and style while staying within your budget.

Get more for less... that's the essence of Brigade.

Cool, comfortable and confident.

Welcome to our new range of Chef's Clothing from Brigade.



GUIDE TO SIZING / FITS

See Page 199 for all Size Guides

Contents

Jackets	Trousers	T-Shirts & Polo Shirts	Money Pockets & Aprons	Headwear & Neckerchiefs	Embroidery Service
190	192	193	194	196	198



Chef Jackets - Unisex

THE CLASSIC CHEF JACKETS

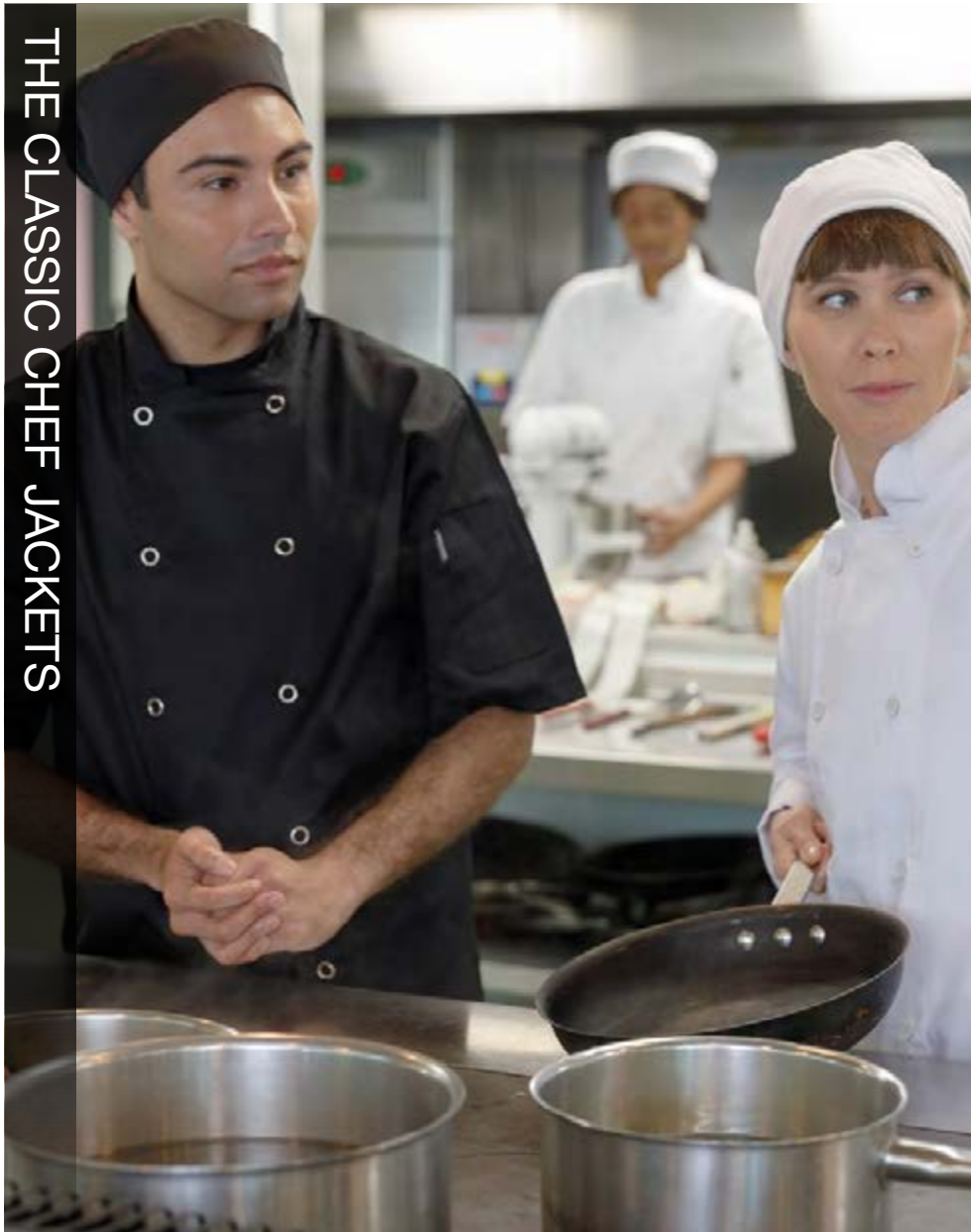

Pen Pocket



Press Stud



Button

The Classic Chef Jackets

Designed for working long hours in busy kitchens, the Brigade Classic Chef Jacket is made from a lightweight polycotton blend to offer added durability for everyday wear. The jacket also includes a useful pen pocket.

Available with a choice of fastening, colour and sleeve length: Press Studs or Buttons, Black or White, Long Sleeve or Short Sleeve.

- 190gsm
- 80/20 Polycotton Twill
- Pen Pocket
- Press Studs or Buttons
- Black or White
- Long Sleeve or Short Sleeve

Press Stud

Long Sleeve

- Q2971** | White, S-2XL
- Q2973** | Black, S-2XL

Short Sleeve

- Q2972** | White, S-2XL
- Q2974** | Black, S-2XL

Button

Long Sleeve

- Q2975** | White, S-2XL
- Q2977** | Black, S-2XL

Short Sleeve

- Q2976** | White, S-2XL
- Q2978** | Black, S-2XL

When ordering, please add your size to the product code e.g. Q2972-M.
Please check the Sizing Guide on page 199 before ordering.

Chef Jackets - Unisex

BREATHABLE CHEF JACKET



Breathable Chef Jacket

Made using a durable, lightweight polycotton twill, the Brigade Breathable Chef Jacket is designed with a mesh back panel to ensure chefs keep cool in extreme heat throughout service. The lightweight, short-sleeved style offers added ventilation and extra comfort. Also includes a useful pen pocket.

- 190gsm
- 80/20 Polycotton Twill
- Pen Pocket
- Press Studs
- Mesh Vented Back Panel

Short Sleeve

Q2979 | White, S-2XL

When ordering, please add your size to the product code e.g. Q2979-M.
Please check the Sizing Guide on page 199 before ordering.

Trousers - Unisex

CHEF TROUSERS

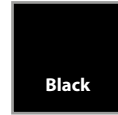

Chef Trousers

The new Brigade Chef Trousers are designed to offer a professional look while being practical and durable. An elasticated waist with a drawcord feature provides more freedom of movement and comfort during long and busy shifts. The four-pocket design offers added convenience. Available in three colour options - Black, Small Blue Check and Large Black Check.

- Drawcord Elasticated Waistband
- Two Side Pockets
- Two Back Pockets

- Q2980** | Black, 190gsm, 80/20 Polycotton, S - 2XL
- Q2981** | Small Blue Check, 165gsm, 65/35 Polycotton, S - 2XL
- Q2982** | Large Black Check, 200gsm, 100% Polyester, S - 2XL

When ordering, please add your size to the product code e.g. Q2980-L.
Please check the Sizing Guide on page 199 before ordering.

T-Shirts & Polo Shirts

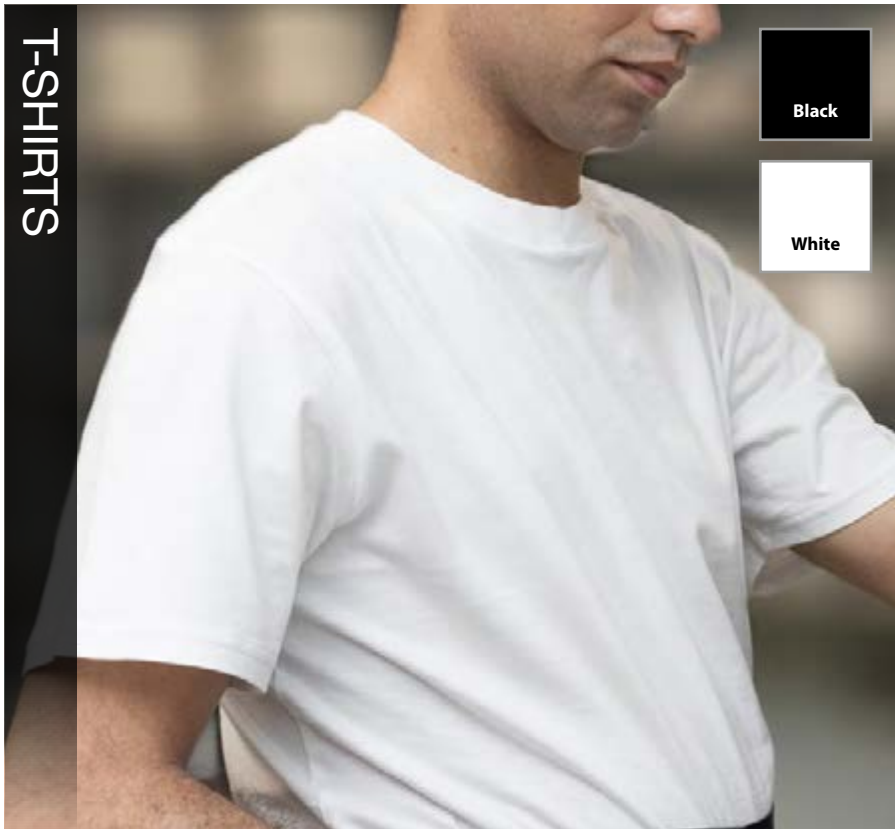

Cotton T-Shirts

The new Brigade T-Shirts are perfect to wear in both front-of-house and back-of-house environments. Made from 100% cotton, the t-shirts are breathable and durable whilst being soft and comfortable.

Ideal for everyday wear. Available in black and white.

- 160gsm
- 100% Cotton

Q2987 | White, S - 2XL
Q2988 | Black, S - 2XL

When ordering, please add your size to the product code e.g. Q2987-S
 Please check the Sizing Guide on page 199 before ordering.

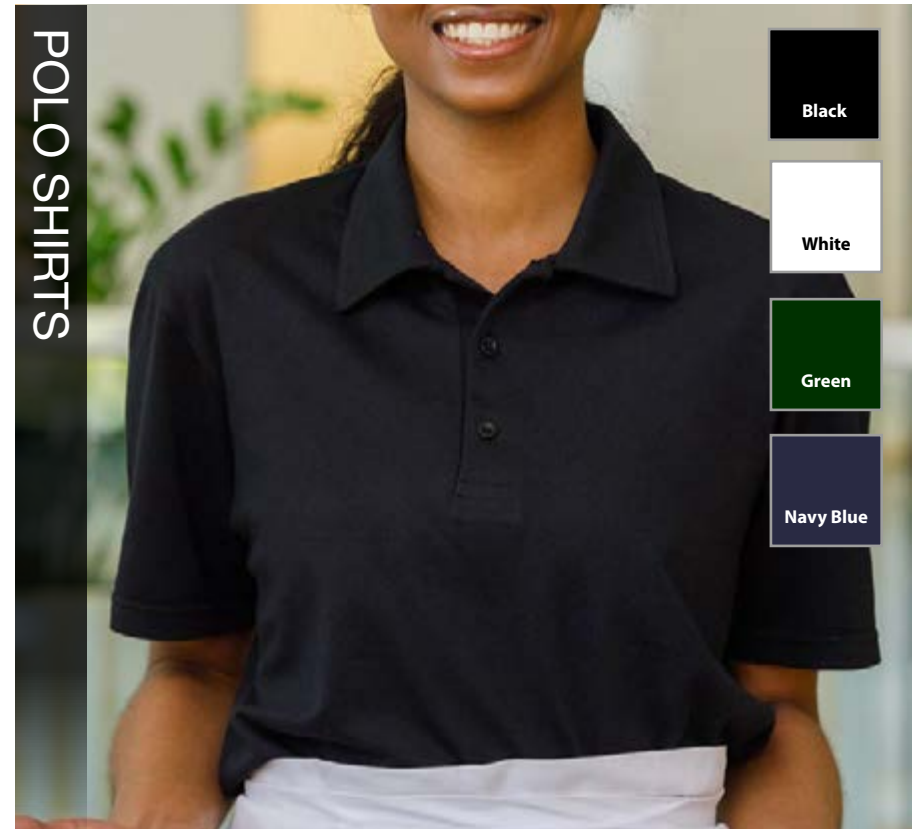

Polo Shirts

As the perfect solution for both front and back of house, the new Brigade Polo Shirt is designed for ultimate comfort and durability. Available in four colours - Black, White, Navy and Green.

- 180gsm

Q2983 | Black, 60/40 Polycotton, S-2XL
Q2984 | White, 60/40 Polycotton, S-2XL
Q2985 | Green, 60/40 Polycotton, S-2XL
Q2986 | Navy Blue, 65/35 Polycotton, S-2XL

When ordering, please add your size to the product code e.g. Q2987-S
 Please check the Sizing Guide on page 199 before ordering.

Money Pockets & Aprons



Money Pockets

Add convenience to staff uniform with the black polycotton money pocket apron. Available with or without a concealed zip, a great hands-free way to carry essentials.

- 190gsm
- 80/20 Polycotton Twill
- Black

Money Pocket With Zip

Q2989 | One Size

Money Pocket

Q2990 | One Size



Short Waist Aprons

Ideal for service staff, the Brigade Short Waist Apron is lightweight and durable. Add style and professionalism with matching colour ties and a useful front pocket. Available in three colours. One size.

- 190gsm
- 80/20 Polycotton Twill
- A5 Size Pocket
- Matching Colour Ties
- 40 x 75cm

Q2992BK | Black

Q2992WH | White

Q2992BS | Blue Stripe

Aprons



Waist Aprons

The versatile Brigade Waist Apron is perfect for use in any kitchen, bar or service environment. Designed for style and comfort, the durable material will ensure it always looks professional. Available in six colours. One size.

- 190gsm
- 80/20 Polycotton Twill
- A5 Size Pocket
- Matching Colour Ties
- 76 x 90cm

Q2991BK	Black
Q2991MT	Merlot
Q2991NB	Navy Blue
Q2991WH	White
Q2991GR	Green
Q2991BS	Blue Stripe



Bib Aprons

The Brigade Bib Apron is an essential for every kitchen. Durable and lightweight, it is comfortable for everyday wear. A versatile piece, with matching colour ties, brings a professional touch to any kitchen or service operation. One size fits all.

Available in seven colours.

- 190gsm
- 80/20 Polycotton Twill
- Matching Colour Ties
- 96 x 72cm

Q2993BK	Black
Q2993WH	White
Q2993BS	Blue Stripe
Q2994GR	Green
Q2994RD	Red
Q2994NB	Navy Blue
Q2994MT	Merlot

Headwear & Neckerchiefs

SKULL CAPS



Skull Caps

One size fits all. Available in five colours.

- 190gsm
- 80/20 Polycotton Twill
- Elasticated Back

Q2995BK | Black
Q2995WH | White
Q2995NB | Navy Blue

Q2995GR | Green
Q2995RD | Red

MESH BEANIE HATS



Mesh Beanie Hats

Practical and breathable, the Brigade Mesh Beanie is made from a ventilated fabric keeping the wearer fresh and cool. One size fits all. Available in Black and White.

- 135gsm
- 100% Polyester Mesh Fabric

Q2996WH | White
Q2996BK | Black

Headwear & Neckerchiefs



Baseball Caps

One size fits all. Available in three colours.

- 170gsm
- 100% Polyester
- Six Panel

Q2997BK | Black
Q2997WH | White
Q2997NB | Navy Blue

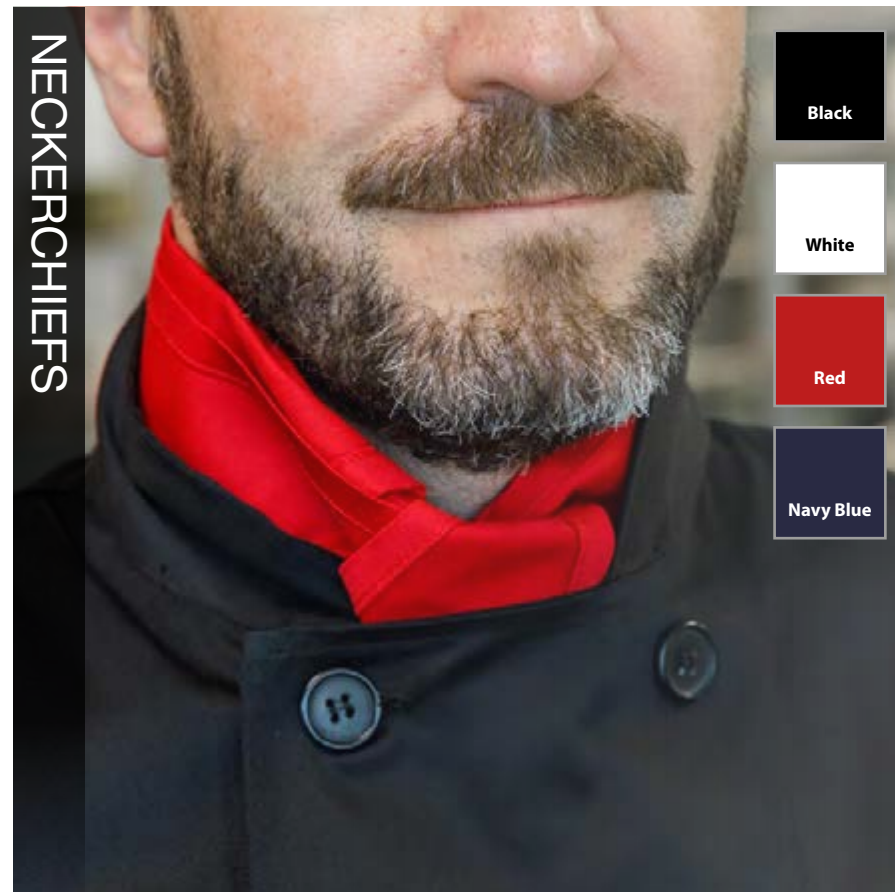

Neckerchiefs

One size fits all. Available in four colours.

- 190gsm
- 80/20 Polycotton Twill

Q2998BK | Black
Q2998WH | White
Q2998RD | Red
Q2998NB | Navy Blue

Personalise your Chefs' Clothing using our embroidery service...

All we need to know...

- ✓ Item list and quantities
- ✓ Logo location
- ✓ If any names and titles are required and if so, required embroidery colour
- ✓ High resolution image of your logo(s)

We will do the rest...

A member of our excellent customer service team will work with you to create your personalised clothing.

To enquire more about our Bespoke Embroidery service, call the sales team now.



Sizing Guides

Jackets

Size Ordering Chart

Size	Chest Size	Size	Chest Size
S	36" - 38"	XL	48" - 50"
M	40" - 42"	2XL	52" - 54"
L	44" - 46"		

Trousers

Size Ordering Chart

Size	Waist Size	Size	Waist Size
XS	26" - 28"	L	38" - 40"
S	30" - 32"	XL	42" - 44"
M	34" - 36"	2XL	46" - 48"

T-Shirts & Polo Shirts

Size Ordering Chart

Size	Chest Size	Size	Chest Size
S	36" - 38"	XL	48" - 50"
M	40" - 42"	2XL	52" - 54"
L	44" - 46"		



When ordering Jackets, Trousers, T-Shirts & Polo Shirts:

Please quote the product code for the style required followed by a dash and the relevant size, e.g., for product code Q2972 in Large, quote Q2972-L.

PREPARA - KITCHEN UTENSILS



prepara



CONTENTS



prepara

Prepara offers a wide range of great quality products for food preparation and storage. Level up in the kitchen with our amazing collection of knives, chopping boards, thermometers, chafing fuels & dishes, gastronomic dishes, pans and a variety of cooking utensils to suit just about any food preparation task... all at unbeatable prices and now including trolleys.

Our Preparara Induction Pans have passed the rigorous testing of the Craft Guild of Chefs, and have been given the official title of 'Approved Product', so you can be assured of Preparara's durability & quality.

COLOUR CODED KNIVES

	Black	Red	Blue	Yellow	Brown	Green	White	Pink	
01	E5300A	E4024A	-	-	E4106A	E4053A	-	-	Paring Knife 3½" / 9cm
02	E5301A	-	-	-	E4107A	E4052A	-	EG115	Vegetable Knife 4" / 10cm
03	E5302A	-	-	-	-	E4188A	-	-	Serrated Vegetable Knife 4" / 10cm
04	-	-	E4101A	-	-	-	-	-	Filleting Knife 6" / 15cm
05	E5306A	E4020A	-	E4030A	-	E4054A	E4036A	-	Cooks Knife 6¼" / 16cm
05	E5308A	E4021A	E4102	E4031A	E4105A	E4051A	E4037A	EG114	Cooks Knife 8½" / 21cm
05	E5309A	E4022A	E4103	E4032A	E4032B	E6511A	E4038A	-	Cooks Knife 10" / 25cm
06	E5318	-	-	-	-	-	E4045	-	Bread/Carving Knife 10" / 25cm
06	E3226	-	-	E4033A	-	-	E4042A	-	Bread/Carving Knife 12" / 30cm
06	-	-	-	-	-	-	E3304	-	Bread/Carving Knife 14" / 35cm
07	-	-	-	E4199	-	-	-	-	Scalloped Slicer 12" / 30cm
08	-	-	-	-	-	-	E4041A	-	Fork 6" / 15cm



01



02



03



04



05



06



07



08



09



10



11



12

09 E4026 Stiff Boning Knife 6" / 15cm - Red

10 E3279 Palette Knife 4" / 10cm - White

10 E5316A Palette Knife 8" / 20cm - Black

10 E4003 Palette Knife 8" / 20cm - White

11 E5313A Sharpening Steel 12" / 30cm - Black

12 EH102 Steak/Tomato Serrated Black 4"

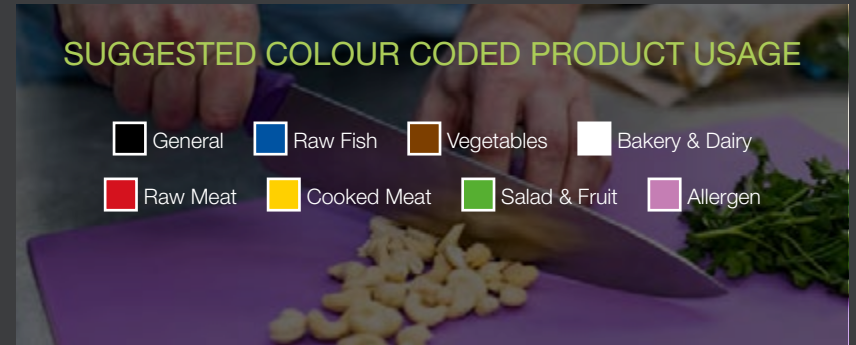

Knife Sets

13 EG116 7 Piece Knife Set - Colour Coded

14 EG117 Starter 8 Piece Knife Set -Black

10" Cooks Knife - Red
8" Cooks Knife - Brown
10" Slicer Serrated - Yellow
6" Boning Knife - Red
6" Fillet Knife - Blue
3.5" Paring Knife - Brown
Wallet

10" Cooks Knife - Black
10" Slicer Serrated - Black
6" Boning Knife - Black
6" Fillet Knife - Black
8" Pallete Knife - Black
10" Sharpening Steel
3" Paring Knife
Wallet

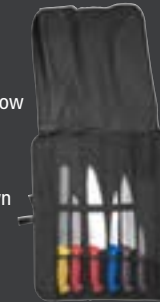

13



14



15

Magnetic Knife Rack

15 E3263 Stainless Steel, 50cm long

COLOUR CODED CUTTING BOARDS



01



02

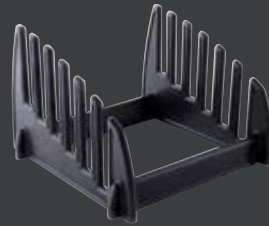

03



04



05

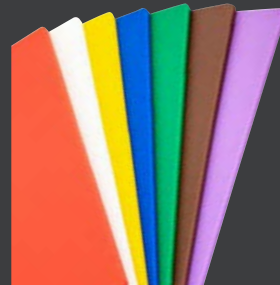

06

- 01 E3942 Non-Slip Mat Roll 1.53m x 30.4cm
- 02 E4014 Storage Rack Stainless Steel, for boards up to 25mm thick
- 03 EC206 Flat Pack Rack For 12mm boards
- 04 E3699 Colour Coded Wall Chart 28cm x 20cm
- 05 EC138 Colour Coded Cutting Board Set 45cm x 30cm x 12mm
- 06 EI029 Colour Coded Chopping Board Set 7 Pcs

Low Density Colour Coded Cutting Boards

E6395	E6397	E6396	E6399	E6398	E6394	EG218	45 x 30 x 1.2cm thick
EG483	EG485	EG484	EG487	EG486	EG482	-	45 x 30 x 2.5cm thick



Red - Raw Meat



Blue - Raw Fish



Yellow - Cooked Meats



Brown - Vegetables



Green - Salad & Fruits



White - Bakery & Dairy

High Density Colour Coded Cutting Boards

E4200	E4203	E4201	E4204	E4202	E4211	30cm x 23cm x 1.2cm
E3701	E3703	E3702	E3705	E3704	E3700	46cm x 30cm x 1.2cm
E3707	E3709	E3708	E3711	E3710	E3706	61cm x 44cm x 1.2cm
E7856	E7857	E7859	E7860	E7858	E7861	46cm x 30cm x 2cm
E7862	E9242	E7864	E7865	E7863	E7866	61cm x 44cm x 2cm
E4133	E4159	E4134	E4169	E4132	E4135	46cm x 30cm x 2.5cm
E1541	E1543	E1542	E1545	E1544	E1540	61cm x 44cm x 2.5cm

THERMOMETERS



01



02



03

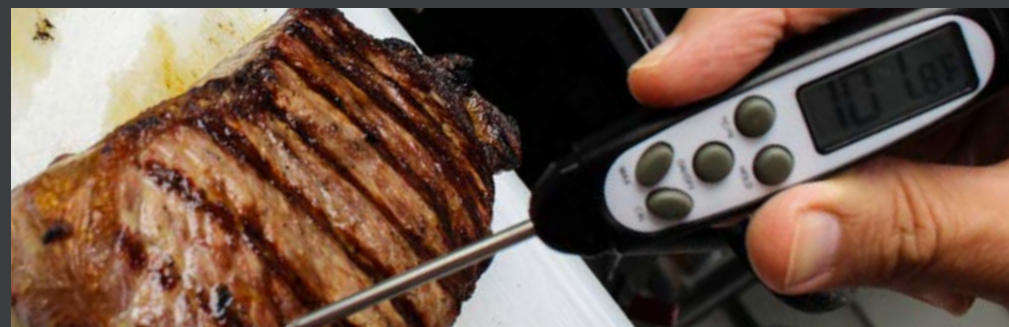

Digital Thermometers

- | | | | | | |
|----|----------------|-----------------------------------------------------|----|--------------|--------------------------------------------------------|
| 01 | EC897WH | Electronic Thermometers
-50°C to +300°C - White | 02 | EC899 | Infrared Thermometer
-50°C to 530°C |
| 01 | EC897BL | Electronic Thermometers
-50°C to +300°C - Blue | 03 | E3119 | Digital Hand Held Thermometer
-50°C to +200°C |
| 01 | EC897RD | Electronic Thermometers
-50°C to +300°C - Red | 04 | E4490 | Pocket Digital Thermometer
-50°C to +150°C |
| 01 | EC897YL | Electronic Thermometers
-50°C to +300°C - Yellow | 05 | ED158 | Digital Fridge / Freezer
Thermometer -50°C to +70°C |
| 01 | EC897PP | Electronic Thermometers
-50°C to +300°C - Purple | | | |



04



05



06



07

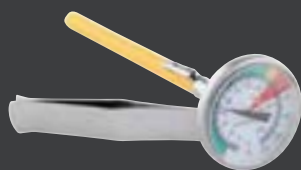

08



09

Analogue Thermometers

- | | | | | | |
|----|--------------|------------------------------------------------------------------|----|--------------|------------------------------------------------|
| 06 | DB074 | Coffee Thermometer 5" -10°C to +110°C. | 09 | E3100 | Fridge / Freezer Thermometer
-40°C to +30°C |
| 06 | DB075 | Attachment clip | 10 | E4163 | Dial Model Thermometer
-30°C to +30°C |
| 07 | E3737 | Coffee / Milk Thermometer -10°C to +110°C. | 11 | E4263 | Hanging Model Thermometer
-30°C to +40°C |
| 08 | E3727 | Milk Thermometer -18°C to +110°C - Jug mounting clip 12.5cm stem | 12 | E1147 | Water Proof Thermometer -50C to +200C |



10



11

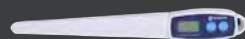

12

SCALES



01



02

Ultra slim electronic scale with easy-to-read LCD display and stainless steel disc platform. Weigh directly onto platform or use with a bowl. Features include liquid measure function, and add and weigh zero facility. Available in black or white colourway.



03

Heavy duty construction platform scales are designed to use in harsh and wet kitchen environment.

- Removable platform for easy cleaning
- Wipe clean splash proof fascia
- Digital dual readout back and front
- Switchable between metric or imperial
- Touch button controls

Battery or Mains operated (An Adaptor and 2 x 1.5V type D batteries included). Please DO NOT use both. Scales are not government stamped for retail food sales.

Platform Scales

- 01 EF098 Disc Platform Scale - Black, 5kg x 1g/11lb x 1/8oz, 5,000ml x 1ml/175fl oz x 1/8fl oz
- 02 EF097 Disc Platform Scale - White, 5kg x 1g/11lb x 1/8oz, 5,000ml x 1ml/175fl oz x 1/8fl oz
- 03 EF232 Platform Scale - 3kg x 1g (6lb x 0.1oz)
- 03 EF233 Platform Scale - 15kg x 5g (33lb x 0.2oz)
- 03 EF234 Spare adaptor for EF232 & EF233
- 04 EF231 Platform Scale - 5kg x 1g/11lb x 1/8oz, 5,000ml x 1ml/175fl oz x 1/8fl oz
- 05 EF227 Scale with Stainless Steel Bowl, 5kg x 20g (11lb x 1oz)
- 06 EF230 Platform Scale - White, 20kg x 50g (44lb x 2oz)



04

Electronic scale, suitable for weighing dry or liquid ingredients in both metric and imperial. Weigh directly onto platform or use with a bowl. Features include easy-to-read LCD display, liquid measure function and add and weigh 'zero' facility.



05



06

CHAFING DISHES & FUELS



01



02

Stackable Chafers - 1/1 GN Size

- 01 **M0123** Chafing Dish (Sold singly) 63.5 x 36 x 33(h)cm
- 02 **D9977** Chafing Dishes (Pack of 2) 63.5 x 36 x 33(h)cm



03



04



05

Chafing Fuels

- 03 **DN002** Gel Fuel 72 x 2.5 hour tin
- 04 **DN003** Gel Fuel 72 x 3 hour tin
- 05 **M0149** Wick Fuel 24 x 4 hour tin
- 05 **M0150** Wick Fuel 24 x 6 hour tin



UTENSILS



Stainless Steel Hook Handle Serving Utensils

- 01 **E8884** Serving Tongs 24cm - 18/10 Stainles Steel
- 02 **E8780** Solid Spoon 35.5cm - 18/10 Stainles Steel
- 03 **E8783** Slotted Spoon 35.5cm - 18/10 Stainles Steel
- 04 **E8782** Ladle 100ml, 34cm - 18/10 Stainles Steel
- 05 **E8781** Turner 37cm - 18/10 Stainles Steel

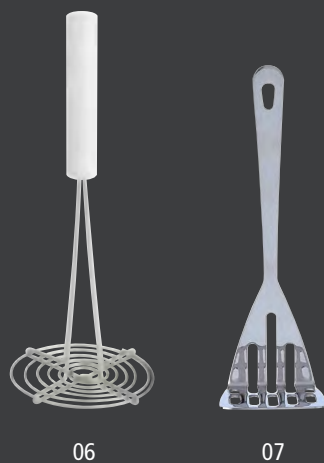

Potato Mashers

- 06 **E2792** 13cm dia head
- 07 **E4503** one piece, 35cm long



Potato Peeler

- 08 **E2936** All metal.

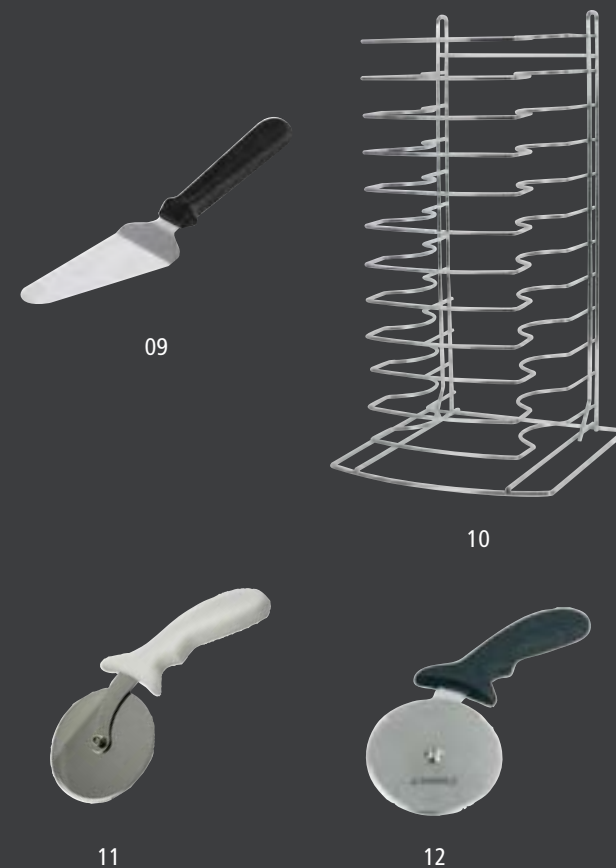

Pizza Utensils

- 09 **E3905** Pizza Server - 15cm blade
- 10 **E6845** Pizza Rack - 12 pan slots, 56cm (h)
- 11 **ED382WH** Pizza Wheel Cutter, White Handle
- 12 **E6422** Pizza Wheel Cutter, Black Handle

UTENSILS



01

Light Quality Whisks

- 01 **E2874** Light Quality Whisk Stainless Steel 25cm
- 01 **E2869** Light Quality Whisk Stainless Steel 30cm
- 01 **E2870** Light Quality Whisk Stainless Steel 35cm
- 01 **E2871** Light Quality Whisk Stainless Steel 40cm
- 01 **E2872** Light Quality Whisk Stainless Steel 46cm



02

Heavy Quality Whisks

- 02 **E7086** Heavy Quality Whisk Stainless Steel 25cm
- 02 **E2859** Heavy Quality Whisk Stainless Steel 30cm
- 02 **E2860** Heavy Quality Whisk Stainless Steel 35cm
- 02 **E2861** Heavy Quality Whisk Stainless Steel 40cm
- 02 **E2862** Heavy Quality Whisk Stainless Steel 46cm



03



04



05



06

Black Handled Lifters

- 03 **E3900** Lifter/Turner Plain blade - 25cm
- 04 **E3901** Lifter/Turner Perforated blade - 25cm
- 05 **E3903** Griddle Scraper Plain blade - 13cm
- 06 **E3902** Hamburger Turner Plain blade - 18cm



07



08



09



10



11

Stainless Steel Lifters

- 07 **E6443** Lifter/Turner Slotted blade 30cm
- 08 **E2858** Flan Lifter 13 x 8cm blade
- 09 **E3315** Egg/Fish Lifter 14 x 11cm blade
- 10 **E3910** Pie Lifter 13 x 8cm blade
- 11 **E2840** Egg/Fish Lifter 11 x 9cm blade

UTENSILS



01

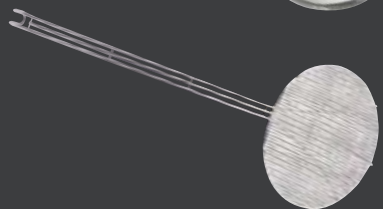

02

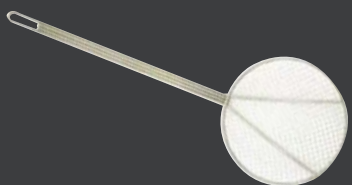

03



04

Skimmers

- 01 **E6592** Skimmer/Strainer 176 x 108mm - 10cm dia x 30cm
- 02 **E2986** Mesh/Stainless Steel 18cm dia x 33.5cm handle
- 03 **EA016** Tinned Steel 12.5cm dia x 32cm handle
- 03 **E2988** Tinned Steel 16cm dia x 34cm handle
- 03 **E2989** Tinned Steel 20cm dia x 34cm handle
- 04 **E2985** Fine Mesh/Tinned Wire 20cm dia x 46cm handle



05



06



07

Chip Shovels

- 05 **E2846** Chip Server 10 x 8cm
- 06 **E2990** Chip Shovel Stainless Steel Blade 20 x 20cm, handle 40cm Fine 30 Mesh
- 06 **E2991** Chip Shovel Stainless Steel Blade 20 x 20cm, handle 40cm Very Fine 60 Mesh
- 07 **E2995** Chip Shovel Stainless Steel Blade 20 x 20cm, handle 40cm Coarse Mesh (1/4")



UTENSILS



01



02



03



04

Stainless Steel Serving Spoons

01 E2889 Plain Bowl / Flat End 25cm long

01 E2890 Plain Bowl / Flat End 28cm long

01 E2891 Plain Bowl / Flat End 33cm long

01 E2892 Plain Bowl / Flat End 40cm long

02 E2893 Perforated Bowl / Flat End 25cm long

02 E2894 Perforated Bowl / Flat End 28cm long

02 E2895 Perforated Bowl / Flat End 33cm long

02 E6564 Perforated Bowl / Flat End 40cm long

03 E2897 Plain Bowl / Hook End 30cm long

03 E2898 Plain Bowl / Hook End 35cm long

04 E2900 Perforated Bowl / Hook End 30cm long

04 E2901 Perforated Bowl / Hook End 35cm long

04 E2902 Perforated Bowl / Hook End 40cm long

Stainless Steel Ladles

05 E3095 30ml, 5cm dia

05 E2882 59ml, 6.5cm dia

05 E2879 89ml, 7cm dia

05 E2880 118ml, 8cm dia

05 E3015 150ml, 9cm dia

05 E2881 180ml, 9.5cm dia

05 E2886 236ml, 10cm dia

05 E2887 354ml, 11.5cm dia



05

Stainless Steel Scoops

06 E2903 Small, 75g

06 E2904 Medium, 113g



06

UTENSILS

- Heat resistant up to 260C
- Dishwasher Safe

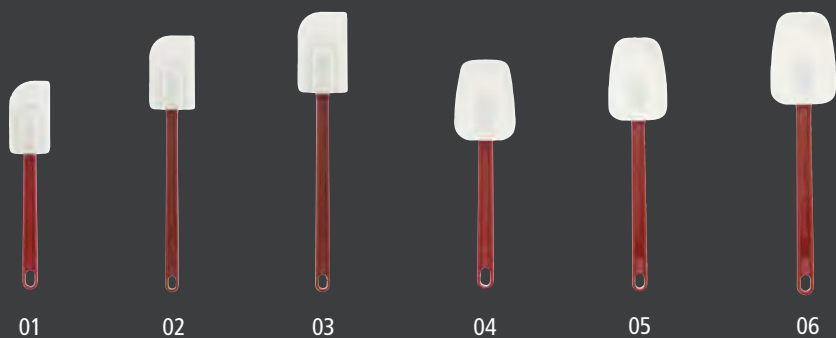

High Heat Silicone Utensils

- 01 **E1162** Silicone High Heat Spatula 25cm
- 02 **E1161** Silicone High Heat Spatula 35.5cm
- 03 **E1160** Silicone High Heat Spatula 40cm
- 04 **E1163** Silicone High Heat Spoon Spatula 25cm
- 05 **E1164** Silicone High Heat Spoon Spatula 35.5cm
- 06 **E1165** Silicone High Heat Spoon Spatula 40cm

Rubber Utensils

- 01 **E1168** Rubber Spatula 25cm
- 02 **E1167** Rubber Spatula 35.5cm
- 03 **E1166** Rubber Spatula 40cm
- 04 **E1170** Rubber Spoon Spatula 25cm
- 05 **E1169** Rubber Spoon Spatula 35.5cm

UTENSILS



Spoodles with Grip 'N Serve Handles

- 01 E4561 Solid Spoodle Red 30cm 59ml, 2oz
- 02 E4562 Solid Spoodle Ivory 31cm 89ml, 3oz
- 03 E4563 Solid Spoodle Green 32cm 118ml, 4oz
- 04 E4564 Solid Spoodle Black 33cm 177ml, 6oz
- 05 E4565 Solid Spoodle Blue 33cm 237ml, 8oz

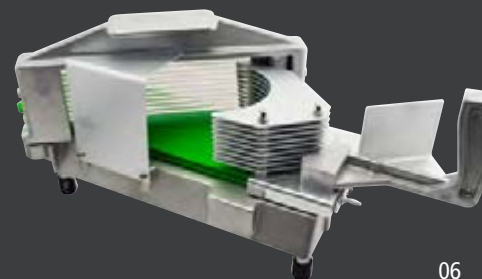

Tomato Slicers

- 06 EE161 1/4" / 6.35mm cut
- 06 EF248 3/16" / 4.76mm cut
- EF395 Spare Blades 3/16"
- EE160 Spare Blades 1/4"
- EF264 Spare Feet (4)
- EF265 Spare Board



Stainless Steel Bowls

- 07 E2713 Round Bowls with a rolled edge 16cm dia, 0.7 Ltr
- 07 E2714 Round Bowls with a rolled edge 20cm dia, 1.1 Ltr
- 07 E2715 Round Bowls with a rolled edge 24cm dia, 2 Ltr
- 07 E2716 Round Bowls with a rolled edge 30cm dia, 4 Ltr
- 08 E4594 Flat Bottom Bowls 15cm dia, 1 Ltr
- 08 E4595 Flat Bottom Bowls 20cm dia, 2.5 Ltr
- 08 E4596 Flat Bottom Bowls 25cm dia, 5 Ltr
- 08 E4597 Flat Bottom Bowls 30cm dia, 8 Ltr



07

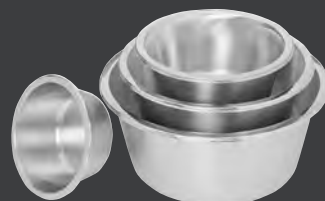

08

Colanders

- 09 E2762 Stainless Steel Colander 24cm dia
- 09 E2763 Stainless Steel Colander 30cm dia
- 09 E2764 Stainless Steel Colander 33cm dia
- 09 E2765 Stainless Steel Colander 40cm dia
- 10 E2768 Aluminium Colander 30cm dia



09



10

TONGS







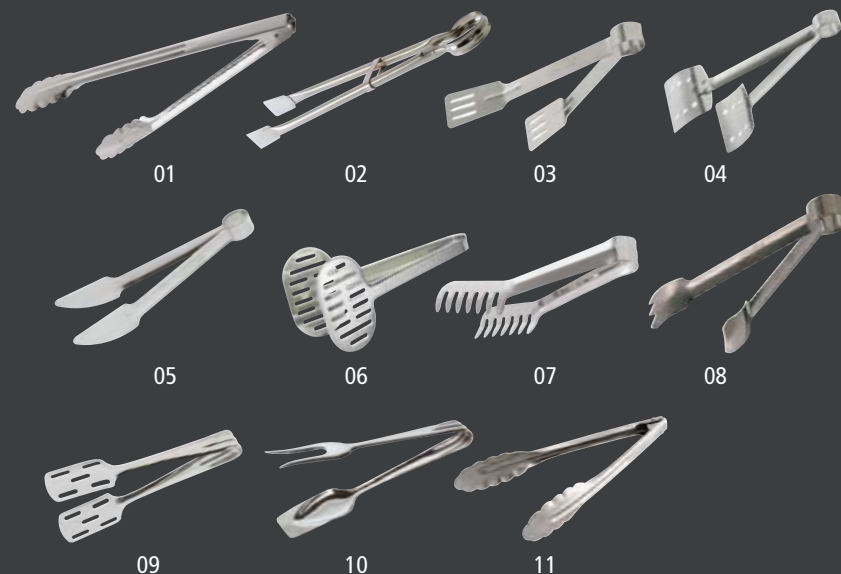

Stainless Steel Tongs

- | | |
|----------------------------------------------------------|--------------------------------------------------------|
| 01 E3167 All-Purpose Tongs 25cm | 06 E1265 Panini / Fish Tongs 23.5cm - Blade 11 x 6.5cm |
| 01 E6645 All-Purpose Tongs 30cm | 07 E3214 Spaghetti Tongs 20cm |
| 01 E6409 All-Purpose Tongs 40cm | 08 E3301 Serving Tongs 21.5cm |
| 02 E2916 Steak Tongs 51cm | 09 E6308 Cake Tongs 19cm overall |
| 03 E2945 Serving / Sandwich Tongs 16cm - Blade 4 x 6.5cm | 10 E6313 Roasting Tongs 20cm |
| 04 E2941 Sausage / Serving Tongs 17cm - Blade 7 x 6cm | 11 E1121 Kitchen Tongs 23.5cm |
| 05 E4484 Hamburger Tongs 23cm | |







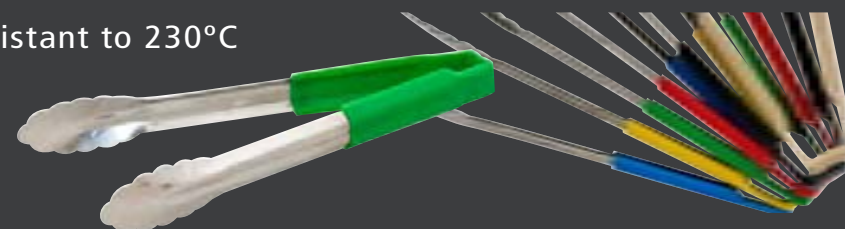

High Heat Colour Coded Silicone Handle Tongs Heat resistant to 230°C

- | | | | | | | |
|-----------------------------------------------------------------------------------|------------------------------------------------------------------------------------|------------------------------------------------------------------------------------|------------------------------------------------------------------------------------|------------------------------------------------------------------------------------|------------------------------------------------------------------------------------|----------------------------------------------------|
|  |  |  |  |  |  | |
| E7101 | E7101B | E7101G | E7101R | E7101T | E7101Y | Stainless Steel Tong with scalloped ends 24cm Size |
| E7102 | E7102B | E7102G | E7102R | E7102T | E7102Y | Stainless Steel Tong with scalloped ends 30cm Size |



Colour Coded Vinyl Handle Tongs

- | | | | | | | |
|------------------------------------------------------------------------------------|-------------------------------------------------------------------------------------|-------------------------------------------------------------------------------------|-------------------------------------------------------------------------------------|-------------------------------------------------------------------------------------|-------------------------------------------------------------------------------------|----------------------------------------------------|
|  |  |  |  |  |  | |
| EA408BK | EA408BL | EA408BR | EA408GR | EA408RE | EA408YE | Stainless Steel Tong with scalloped ends 24cm Size |
| EA409BK | EA409BL | EA409BR | EA409GR | EA409RE | EA409YE | Stainless Steel Tong with scalloped ends 30cm Size |
| EA410BK | EA410BL | - | EA410GR | EA410RE | EA410YE | Stainless Steel Tong with scalloped ends 40cm Size |

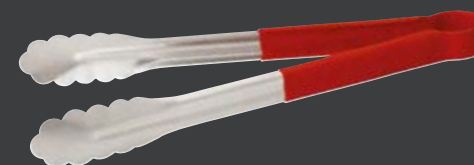

MEDIUM DUTY ALUMINIUM COOKWARE

- Heat resistant stainless steel tubular handles
- Reinforced rim for extra strength
- Fast heat transmission and spreading

(Aluminium is not dishwasher safe. Avoid using corrosive cleaning agents)



ELECTRIC RING



GAS FLAME



SOLID HOTPLATE



CERAMIC HOB

Suitable for all conventional heating methods except induction cooking



Omelette Pan

E2386 20cm dia x 4.5cm



Frying Pans

E2384 24cm dia x 6cm

E8603 28cm dia x 6.5cm

E2408 32cm dia x 7cm



Saucepans

E2421 14cm dia x 9cm x 1.5 Ltr

E2422 16cm dia x 10.6cm x 2 Ltr

E2423 18cm dia x 12cm x 3 Ltr

E2424 20cm dia x 13cm x 4 Ltr

E2425 22cm dia x 15cm x 5.5 Ltr

E2426 24cm dia x 16cm x 7 Ltr

E8601 28cm dia x 18.6cm x 11.5 Ltr



Casseroles

E8607 20cm dia x 10cm x 3 Ltr

E8608 24cm dia x 12cm x 5.5 Ltr

E8609 28cm dia x 14cm x 8.5 Ltr

E8610 32cm dia x 16cm x 13 Ltr

E8611 36cm dia x 18cm x 18 Ltr

E8612 22cm dia x 15cm x 5.5 Ltr



Pan Lids

E8600 14cm dia

E8618 16cm dia

E8619 18cm dia

E8620 20cm dia

E8621 22cm dia

E8622 24cm dia



Stewpans

E2435 16cm dia x 10.6cm x 2 Ltr

E2436 18cm dia x 12cm x 3 Ltr

E2437 20cm dia x 13cm x 4 Ltr

E2438 22cm dia x 15cm x 5.5 Ltr

E2439 24cm dia x 16cm x 7 Ltr

E2440 28cm dia x 19cm x 11.5 Ltr

E2441 30cm dia x 20cm x 14 Ltr

E2442 32cm dia x 21cm x 17 Ltr

E2443 36cm dia x 24cm x 24.5 Ltr

E2445 40cm dia x 26.6cm x 34 Ltr

E2446 45cm dia x 30cm x 49 Ltr



Tall Stewpans / Stockpots

E8613 24cm dia x 24cm x 11 Ltr

E8614 28cm dia x 28cm x 17 Ltr

E8615 32cm dia x 32cm x 26 Ltr

E8616 36cm dia x 36cm x 37 Ltr

E8617 40cm dia x 40cm x 50 Ltr



Milk Saucepan

E2419 16cm dia x 1.1 Ltr



Saucepans

EA412 12cm dia x 1 Ltr

EA413 16cm dia x 2 Ltr

EA414 18cm dia x 3 Ltr

EA415 20cm dia x 4 Ltr

HEAVY DUTY STAINLESS STEEL COOKWARE

An excellent range of heavy duty stainless steel cookware suitable for all cooking surfaces including induction.

- Superb quality stainless steel for better heat conductivity
- 6mm fully encapsulated aluminium base
- Dishwasher safe

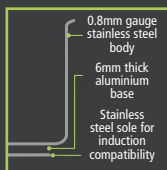

Suitable for all conventional heating methods - including induction cooking. Lids are sold separately.



Saucepans

- ED485** 16cm dia x 7.5cm, 1.5 Ltr
ED486 18cm dia x 10.5cm, 2.5 Ltr
ED487 20cm dia x 10.5cm, 3 Ltr
ED488 24cm dia x 11cm, 5 Ltr
ED489 28cm dia x 13cm, 8 Ltr



Tall Stewpans

- ED496** 24cm dia x 24cm, 10.5 Ltr
ED497 28cm dia x 28cm, 17 Ltr
ED498 32cm dia x 32cm, 25.5 Ltr
ED499 36cm dia x 36cm, 36 Ltr
ED500 40cm dia x 40cm, 49 Ltr
ED501 45cm dia x 45cm, 71.5 Ltr



Stewpans

- ED490** 24cm dia x 16cm, 7 Ltr
ED491 28cm dia x 15.5cm, 9.5 Ltr
ED492 32cm dia x 16.5cm, 12.5 Ltr
ED493 36cm dia x 18cm, 18.5 Ltr
ED494 40cm dia x 25cm, 31.5 Ltr
ED495 45cm dia x 28cm, 44.5 Ltr



Low Casserole Pans

- ED502** 28cm dia x 13cm, 7.5 Ltr
ED503 36cm dia x 14cm, 13 Ltr



Sauteuse Pans

- E8527** 16cm dia x 6cm, 1.2 Ltr
E8528 20cm dia x 6.5cm, 2 Ltr
E8529 24cm dia x 7.5cm, 3.4 Ltr



Frying Pans

- E8521** 20cm dia x 4(h)cm
E8522 24cm dia x 5(h)cm
E8523 28cm dia x (h)cm
E8524 32cm dia x 5(h)cm
E8525 36cm dia x 6(h)cm



Pan Lids

- E8551** 16cm dia
E8552 18cm dia
E8553 20cm dia
E8554 24cm dia
E8555 28cm dia
E8556 32cm dia
E8557 36cm dia
E8558 40cm dia
E8559 45cm dia

TEFLON PLATINUM PLUS ALUMINIUM NON-STICK PANS

- Teflon Plus non-stick coating for extra long life
- Heavy weight aluminium for excellent heat retention
- Sturdy riveted handles

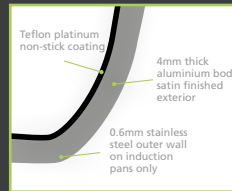

- 01 ED360 Frying Pan 20cm
- 01 ED361 Frying Pan 24cm
- 01 ED362 Frying Pan 26cm
- 01 ED363 Frying Pan 28cm
- 01 ED364 Frying Pan 30cm
- 01 ED365 Frying Pan 32cm
- 01 ED366 Frying Pan 36cm

- 01 ED367 Frying Pan 40cm
- 02 ED369 Flared Sauté Pan 24cm
- 02 ED370 Flared Sauté Pan 28cm
- 03 ED376 Square Ribbed Skillet 24 x 24cm
- 04 ED368 Oval Fishpan 36cm
- 05 ED375 Wok 30cm
- 06 ED374 Paella Pan 36cm 36cm dia



07



08

- 07 ED372 Blini Pan 12cm
- 07 ED373 Blini Pan 15cm
- 08 ED371 Crêpe Pan 26cm



Induction Pans

High performance non-stick pans which are induction compatible.

- Sturdy rivet handles
- Highly scratch resistant
- Suitable for use on induction cookers

- 09 ED377 Frying Pan 20cm
- 09 ED378 Frying Pan 24cm
- 09 ED379 Frying Pan 26cm
- 09 ED380 Frying Pan 28cm
- 10 ED381 Flared Sauté Pan 24cm



TEFLON PROFILE ALUMINIUM NON-STICK PANS

Teflon's highest grade non-stick coating designed for ambitious professionals

- Significantly improved abrasion resistance
- Superb nonstick performance
- Maximum continuous in use temperature: 260°C on all surfaces
- Allows the use of metal utensils



Unique Technology - patent pending -

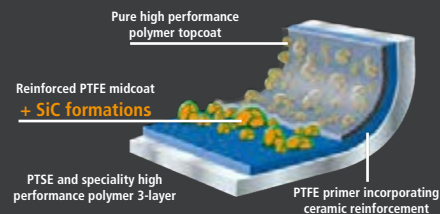

An important ingredient in the skin technology is Silicon Carbide (SiC), which is well known in nature for its strength. We used chemically synthesized SiC particles to achieve a hardness that is almost equal to diamonds. In the Teflon Profile Midcoat, the SiC particles aggregate into little clusters, forming the innovative surface texture that gives the nonstick coating and scratch resistance.



- 01 EH070 Blini 12cm
- 02 EH071 Blini 15cm
- 03 EH072 Crêpe Pan 26cm
- 04 EH073 Sauté Pan 24cm
- 04 EH074 Sauté Pan 28cm
- 05 EH075 Wok 30cm
- 06 EH076 Frying Pan 20cm

- 06 EH077 Frying Pan 24cm
- 06 EH078 Frying Pan 26cm
- 06 EH079 Frying Pan 28cm
- 06 EH080 Frying Pan 30cm
- 06 EH081 Frying Pan 32cm
- 06 EH082 Frying Pan 36cm
- 06 EH083 Frying Pan 40cm



Induction Pans

High performance profile non-stick pans which are induction compatible.

- 07 EH084 Frying Pan 20cm - Induction
- 07 EH085 Frying Pan 24cm - Induction
- 07 EH086 Frying Pan 26cm - Induction
- 07 EH087 Frying Pan 28cm - Induction
- 07 EH088 Frying Pan 30cm - Induction
- 08 EH073 Sauté Pan 24cm - Induction



CAST-IRON COOKWARE

Cast-Iron Griddle & Sizzle Platter

Cast iron provides exceptional heat retention and is suitable for all cooking surfaces. Not dishwasher safe.



01

Reversible Large Griddle

01 E6762 Ribbed One Side, Smooth The Other - 48 x 26.5cm



02

Oval Sizzle Platter Set

02 D4389 Cast Iron Dish 24 x 14cm and Lifter With Wood Trivet 29.3 x 15.5cm



NON-STICK BAKEWARE



01



02



03

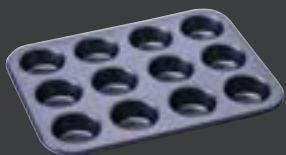

04



05



06

Non-Stick Bakeware

- | | | | | | |
|----|-------|---------------------------------------------------|----|-------|--------------------------------------|
| 01 | ED425 | Loaf Tin 21 lbs | 04 | ED422 | Muffin Tin 12 Cup, 35 x 26.5 x 28cm |
| 02 | ED427 | Springform Cake Tin 20cm dia x 6.8cm | 05 | ED423 | Muffin Tin 6 Cup, 26.5 x 18.5 x 3cm |
| 03 | ED424 | Yorkshire Pudding Tin 4 cup - 23.5 x 23.5 x 1.8cm | 06 | ED428 | Springform Cake Tin 26cm dia x 6.8cm |

NON-STICK SILICONE MOULDS

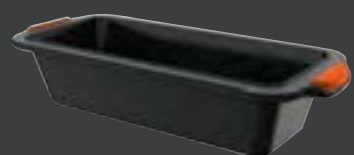

01



02



03



04



05

Non-Stick Bakeware

- 01 EI082 Loaf Pan, 29.8 x 13 x 6.4cm
- 02 EI083 Square Cake Pan, 25.7 x 22.6 x 5.3cm
- 03 EI084 Mini Cake Mould, 35.5 x 24.6 x 2.8cm

- 04 EI085 Muffin Mould 12 Cup, 35.5 x 24.6 x 3.6cm
- 05 EI086 Muffin Mould 6 Cup, 28.4 x 17.2 x 3.4cm



ALUMINIUM BAKEWARE

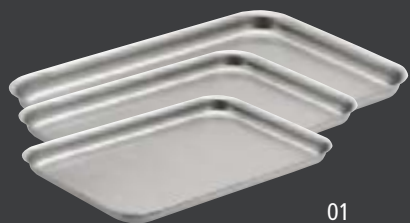

01

Baking Trays

- 01 **E2514** 31 x 21 x 2cm
- 01 **E2515** 36 x 26 x 2cm
- 01 **E2516** 42 x 30 x 2cm
- 01 **E2517** 46 x 35 x 2cm
- 01 **E2518** 52 x 42 x 2cm



02

Bakewell Pans

- 02 **E2506** 31 x 22 x 4cm, 2.2 Ltr
- 02 **E2507** 37 x 26 x 4cm, 3.1 Ltr
- 02 **E2508** 42 x 30 x 4cm, 4.1 Ltr
- 02 **E2509** 47 x 35 x 4cm, 5 Ltr
- 02 **E2510** 52 x 42 x 4cm, 7.3 Ltr
- 02 **E9556** 61 x 46 x 4cm, 8.6 Ltr



03

Baking Pans

- 03 **E7620** 32 x 22 x 5cm, 3.1 Ltr
- 03 **E2535** 37 x 26 x 7cm, 5.6 Ltr
- 03 **E2536** 42 x 30 x 7cm, 8 Ltr
- 03 **E9554** 47 x 35 x 7cm, 10.4 Ltr
- 03 **E2537** 52 x 42 x 7cm, 14 Ltr
- 03 **E9555** 61 x 46 x 7cm, 16.5 Ltr



04

Roasting Dishes

- 04 **E3260** Roasting Dish 32 x 22 x 5cm, 3.1 Ltr
- 04 **E2531** Roasting Dish 37 x 26 x 7cm, 6.1 Ltr
- 04 **E2532** Roasting Dish 42 x 30 x 7cm, 7.9 Ltr
- 04 **E2533** Roasting Dish 47 x 35 x 7cm, 10.5 Ltr
- 04 **E2534** Roasting Dish 52 x 42 x 7cm, 13.4 Ltr
- 04 **E9557** Roasting Dish 61 x 46 x 7cm, 16.5 Ltr



05

- 05 **E2538** Deep Roasting Dish 42 x 30 x 10cm, 11.9 Ltr
- 05 **E2539** Deep Roasting Dish 47 x 35 x 10cm, 15.5 Ltr
- 05 **E2540** Deep Roasting Dish 52 x 42 x 10cm, 20 Ltr
- 05 **E7622** Deep Roasting Dish 61 x 46 x 10cm, 24.5 Ltr

GASTRONORM PANS - STAINLESS STEEL



- 01 **E5524** 1/1 GN - 20mm deep
- 01 **E5493** 1/1 GN - 40mm deep
- 01 **E7020** 1/1 GN - 65mm deep
- 01 **E7023** 1/1 GN - 100mm deep
- 01 **E7026** 1/1 GN - 150mm deep
- 01 **E5492** 1/1 GN - 200mm deep
- 02 **E4703** 1/1 GN Perforated - 20mm deep
- 02 **E4704** 1/1 GN Perforated - 40mm deep
- 02 **E7029** 1/1 GN Perforated - 65mm deep
- 02 **E7031** 1/1 GN Perforated - 100mm deep
- 02 **E4705** 1/1 GN Perforated - 150mm deep
- 02 **E4706** 1/1 GN Perforated - 200mm deep



- 03 **E5506** 1/2 GN - 20mm deep
- 03 **E4709** 1/2 GN - 40mm deep
- 03 **E7021** 1/2 GN - 65mm deep
- 03 **E7024** 1/2 GN - 100mm deep
- 03 **E7027** 1/2 GN - 150mm deep
- 03 **E4710** 1/2 GN - 200mm deep
- 04 **E4711** 1/2 GN Perforated - 20mm deep
- 04 **E4712** 1/2 GN Perforated - 40mm deep
- 04 **E7030** 1/2 GN Perforated - 65mm deep
- 04 **E7032** 1/2 GN Perforated - 100mm deep
- 04 **E4713** 1/2 GN Perforated - 150mm deep
- 04 **E4714** 1/2 GN Perforated - 200mm deep

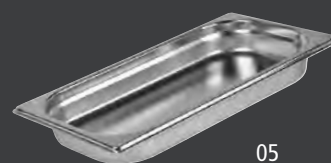

- 05 **E4715** 1/3 GN - 20mm deep
- 05 **E4716** 1/3 GN - 40mm deep
- 05 **E7022** 1/3 GN - 65mm deep
- 05 **E7025** 1/3 GN - 100mm deep
- 05 **E7028** 1/3 GN - 150mm deep
- 05 **E5495** 1/3 GN - 200mm deep



- 06 **E4718** 1/4 GN - 20mm deep
- 06 **E4719** 1/4 GN - 40mm deep
- 06 **E7038** 1/4 GN - 65mm deep
- 06 **E7039** 1/4 GN - 100mm deep
- 06 **E7040** 1/4 GN - 150mm deep
- 06 **E4720** 1/4 GN - 200mm deep



- 07 **E4723** 1/6 GN - 65mm deep
- 07 **E5498** 1/6 GN - 100mm deep
- 07 **E5497** 1/6 GN - 150mm deep
- 07 **E4724** 1/6 GN - 200mm deep



- 08 **E4726** 1/9 GN - 65mm deep
- 08 **E5503** 1/9 GN - 100mm deep
- 08 **E4727** 1/9 GN - 150mm deep

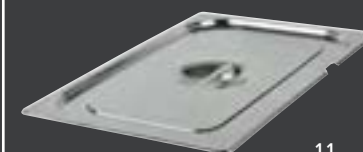

11

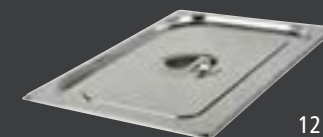

12

Gastronorm lids

- 11 **E5496** 1/1 GN Size - Notched lid
- 11 **E4741** 2/3 GN Size - Notched lid
- 11 **E5499** 1/2 GN Size - Notched lid
- 11 **E5502** 1/3 GN Size - Notched lid
- 11 **E4721** 1/4 GN Size - Notched lid
- 11 **E1008** 1/6 GN Size - Notched lid
- 11 **E4728** 1/9 GN Size - Notched lid
- 12 **E4734** 2/1 GN Size - Plain lid
- 12 **E7033** 1/1 GN Size - Plain lid
- 12 **E4740** 2/3 GN Size - Plain lid
- 12 **EB586** 2/4 GN Size - Plain lid
- 12 **E7034** 1/2 GN Size - Plain lid
- 12 **E7035** 1/3 GN Size - Plain lid
- 12 **E7041** 1/4 GN Size - Plain lid
- 12 **E5501** 1/6 GN Size - Plain lid
- 12 **E5505** 1/9 GN Size - Plain lid

Accessories

- 09 **E7036** Support Bar - 325mm long
- 09 **E7037** Support Bar - 530mm long
- 10 **E4707** Drainer Plate - 1/1 GN Size
- 10 **E4708** Drainer Plate - 1/2 GN Size
- 10 **E4717** Drainer Plate - 1/3 GN Size
- 10 **E4722** Drainer Plate - 1/4 GN Size
- 10 **E4725** Drainer Plate - 1/6 GN Size

Silicone GN Lids

- 01 **EH913** S/S - 1/1GN Lid
- 02 **EH914** S/S - 1/2GN Lid
- 03 **EH915** S/S - 1/3GN Lid
- 04 **EH916** S/S - 1/4GN Lid



03

POLYPROPYLENE GN PANS

- Transparent/ White for clear food identification
- Great for cold & warm food storage
- Perfect fit with GN 1/1, 1/2, 1/3, 1/4, 1/6, and 1/9 solutions
- Available in 65, 100, 150, 200mm depth depending on GN size
- Withstands -40°C to +70°C
- BPA free
- Not suitable on direct heat or microwave, ideal for food storage, keep warm, storage and display
- Stackable

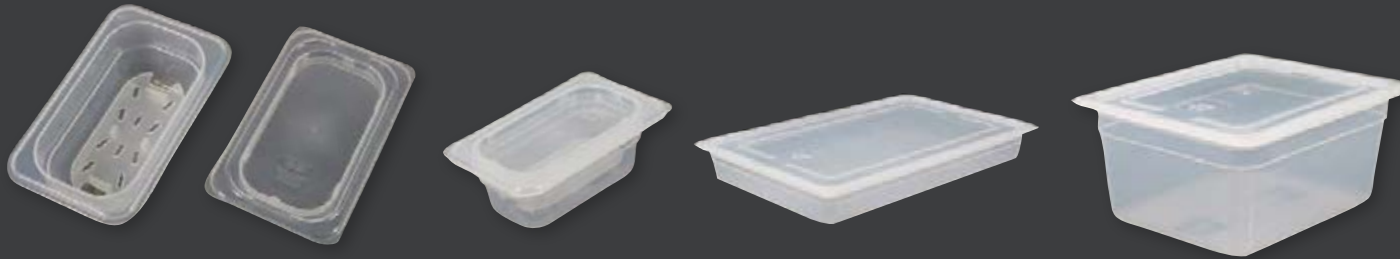

01	EI035	Polyprop Gastronorm Food Pan	1/1 x 65mm
02	EI036	Polyprop Gastronorm Food Pan	1/1 x 100mm
03	EI037	Polyprop Gastronorm Food Pan	1/1 x 150mm
04	EI038	Polyprop Gastronorm Food Pan	1/1 x 200mm
05	EI056	Polyprop Gastronorm Food Pan	1/1 Cover
06	EI062	Polyprop Gastronorm	1/1 Drain Shelf
07	EI039	Polyprop Gastronorm Food Pan	1/2 x 65mm
08	EI040	Polyprop Gastronorm Food Pan	1/2 x 100mm

09	EI041	Polyprop Gastronorm Food Pan	1/2 x 150mm
10	EI042	Polyprop Gastronorm Food Pan	1/2 x 200mm
11	EI057	Polyprop Gastronorm Food Pan	1/2 Cover
12	EI063	Polyprop Gastronorm	1/2 Drain Shelf
13	EI043	Polyprop Gastronorm Food Pan	1/3 x 65mm
14	EI044	Polyprop Gastronorm Food Pan	1/3 x 100mm
15	EI045	Polyprop Gastronorm Food Pan	1/3 x 150mm
16	EI046	Polyprop Gastronorm Food Pan	1/3 x 200mm

17	EI058	Polyprop Gastronorm Food Pan	1/3 Cover
18	EI064	Polyprop Gastronorm	1/3 Drain Shelf
19	EI047	Polyprop Gastronorm Food Pan	1/4x65mm
20	EI048	Polyprop Gastronorm Food Pan	1/4 x 100mm
21	EI049	Polyprop Gastronorm Food Pan	1/4 x 150mm
22	EI059	Polyprop Gastronorm Food Pan	1/4 Cover
23	EI065	Polyprop Gastronorm	1/4 Drain Shelf
24	EI050	Polyprop Gastronorm Food Pan	1/6x65mm
25	EI051	Polyprop Gastronorm Food Pan	1/6x100mm
26	EI052	Polyprop Gastronorm Food Pan	1/6 x 150mm
27	EI060	Polyprop Gastronorm Food Pan	1/6 Cover
28	EI053	Polyprop Gastronorm Food Pan	1/9x65mm
29	EI054	Polyprop Gastronorm Food Pan	1/9x100mm
30	EI055	Polyprop Gastronorm Food Pan	1/9 x 150mm
31	EI061	Polyprop Gastronorm Food Pan	1/9 Cover

TROLLEYS & ACCESSORIES



Prepara Black Insulated Polypropylene Food Carrier 1/1 GN

Reliable, lightweight & perfect for food transportation

05 EH903 1/1 GN 46ltr 600 x 316 x 400mm - Black



NEW

05



06

Heavy Duty Polythene Tray

Food safe contact

06 E3484 56 x 42 x 18cm - Grey



01

02

S/S Service Trolleys

01 HEA128 2 Tier - 860 x 535 x 930mm

02 HEA129 3 Tier - 860 x 535 x 930mm



03

Gastronorm Trolley

03 HEA130 20 Tier x 1/1 GN, 380 x 557 x 1700mm

- Stainless steel construction
- Supplied flat packed – easy to assemble
- Designed to take 20 x 1/1 GN containers
- 4 castors with bumpers, 2 braked



04

Steel construction with white powder coated finish. Foot pedal operated lid. Supplied flat packed.

Sack Holder

04 F3351 43 x 44 x 80.5(h)cm



07

Flat base Bucket

07 F9446 12 Ltr - Stainless Steel

CUTLERY ACCESSORIES



6 Slot Cutlery Dispenser With Holders

- 01 E3038 Dispenser with 6 Holders, 37 x 29.5 x 21.5cm max high
- 02 E3114 Spare Holder for E3038, 11.5cm dia x 13.5cm high



01



02

Holders suitable for stand alone use



03

04

1/1 GN Cutlery Trays

- 03 E3040BL Black, 53 x 32.5 x 10cm
- 04 E3040 Grey, 53 x 32.5 x 10cm



05

5 Compartment Cutlery Box

- 05 E3039 50 x 25 x 10cm - Stainless Steel



ARCTICA

REFRIGERATION



CONTENTS

COUNTERTOP MANUAL ICE MAKERS	228
UNDERCOUNTER REFRIGERATORS & FREEZERS	229
UPRIGHT REFRIGERATORS & FREEZERS	231
REFRIGERATED PREPARATION COUNTERS	236
REFRIGERATED SALADETTE PREPARATION COUNTERS	239
REFRIGERATED PIZZA PREPARATION COUNTERS	240
REFRIGERATED PREPARATION COUNTERS	241
REFRIGERATED PREPARATION TOPS	242
CHEST FREEZERS	243
BOTTLE COOLERS	244
GLASS DOOR DISPLAY REFRIGERATORS	247
UPRIGHT DISPLAY REFRIGERATORS	248
BLAST CHILLER AND FREEZERS	251



ARCTICA REFRIGERATION

Arctica has a wide range of high quality solutions to your refrigeration needs, that combine reliability with highly competitive pricing & come with a warranty of up to 3 years.

The range includes high quality undercounter and upright refrigerators & freezers, preparation counters, pizza/saladette counters, chest freezers, bottle coolers and ice makers.

COUNTERTOP MANUAL ICE MAKERS

12KG Output Countertop Manual Ice Maker

- Stainless steel body, ABS lid
- Supplied with ice scoop
- Easy cleaning
- 12kg/day output
- Ambient temp 40°C
- Cycle time 6 to 13 minutes
- Produces hollow bullet-type ice - size approx 2.3cm x 2cm



HEA653

18KG Output Countertop Manual Ice Maker

- Stainless steel body, ABS lid
- Supplied with ice scoop
- Easy cleaning
- 18kg/day output
- Ice bucket capacity 1.1 kg
- Ambient Temp 32°C
- Cycle time 15 to 20 minutes
- Produces square shape ice cubes



Digital Display



ABS lid



HEF955

Countertop Manual Ice Makers

HEA653 12KG Output Countertop Manual Ice Maker - 242 x 358 x 328mm

HEF955 18KG Output Countertop Manual Ice Maker - 257 x 473 x 522mm



UNDERCOUNTER REFRIGERATORS & FREEZERS

Medium Duty Undercounter Refrigerators & Freezers

This medium duty range of undercounter refrigerators and freezers incorporates energy efficient refrigerant and represents outstanding value for money. This range is designed for commercial use in less demanding environments and operates effectively in kitchens of up to 30°C.

- 143 Litres capacity
- White aluminium interior
- 2 x full size shelves & 1 x half shelf
- Lockable right-hand hinged door
- Digital thermometer display and controller
- Supplied with adjustable front feet, with rollers at the rear
- Incorporates energy efficient refrigerant
- Manual defrost
- Operates in up to 30°C Ambient conditions



HEC906



HEC907



Glass Door Version Available
- see page 247

Refrigerators (0°C to +8°C)

- HEC906 Refrigerator White Exterior Finish - 595 x 653 x 880mm
- HEC907 Refrigerator Stainless Steel Exterior Finish - 595 x 653 x 880mm

Freezers (-18°C to -22°C)

- HEC908 Freezer White Exterior Finish - 595 x 653 x 880mm
- HEC909 Freezer Stainless Steel Exterior Finish - 595 x 653 x 880mm



UNDERCOUNTER REFRIGERATORS & FREEZERS

Heavy Duty Undercounter Refrigerator & Freezer

This new heavy-duty range of undercounter refrigerator and freezer is designed for busy kitchens, where the units are continuously in use. As well as incorporating energy efficient refrigerant, the units are full stainless steel interior/exterior finish and operate effectively in kitchens of up to 40°C.

- 145 Litres capacity
- Stainless steel interior & exterior
- Supplied with 2 shelves /6 shelf positions
- Lockable right-hand hinged door
- Digital thermometer display and controller
- Supplied on castors (two braked)
- Incorporates energy efficient refrigerant
- Manual defrost on HEF138
- Auto defrost on HEF139
- Operates in up to 40°C Ambient conditions

FEATURES



All Stainless Steel
Interior/ exterior finish



Climate Class 5
Designed to operate
in high ambient conditions



Fully Supported
3 year warranty



Refrigerator (+2°C to +8°C)

- Eco Design: Rating A+, Climate Class 5, Heavy Duty

HEF138 Refrigerator Stainless Steel Exterior Finish - 605 x 635 x 825mm

Freezer (-17°C to -22°C)

- Eco Design: Rating C, Climate Class 5, Heavy Duty

HEF139 Freezer Stainless Steel Exterior Finish - 605 x 635 x 825mm



UPRIGHT REFRIGERATORS & FREEZERS

Medium Duty - 356 Ltr Capacity Upright Refrigerators & Freezers

A range of medium duty upright cabinets that incorporates energy efficient refrigerant and represents outstanding value for money. This range is designed for commercial use in less demanding environments and operates effectively in kitchens of up to 30°C.

- 356 Litres capacity
- White aluminium interior
- 3 x full size shelves & 1 x half shelf on refrigerators
6 x full size shelves & 1 x half shelf on freezers
- Lockable right-hand hinged door
- Digital thermometer display and controller
- Supplied with adjustable front feet, with rollers at the rear
- Incorporates energy efficient refrigerant
- Eco Design: Rating D, Climate Class 4, Normal Duty
- Manual defrost (Auto on freezer models)
- Operates in up to 30°C Ambient conditions



HEC911



HEC910



Glass Door Version
Available
- see page 250

Refrigerators (0°C to +8°C)

- HEC910 Refrigerator White Exterior Finish - 595 x 653 x 1840mm
- HEC911 Refrigerator Stainless Steel Exterior Finish - 595 x 653 x 1840mm

Freezers (-18°C to -22°C)

- HEC912 Freezer White Exterior Finish - 595 x 653 x 1840mm
- HEC913 Freezer Stainless Steel Exterior Finish - 595 x 653 x 1840mm



UPRIGHT REFRIGERATORS & FREEZERS

Medium Duty - 580 Ltr Capacity Upright Refrigerators & Freezers

A range of medium duty upright cabinets that incorporates energy efficient refrigerant and represents outstanding value for money. This range is designed for commercial use in less demanding environments and operates effectively in kitchens of up to 30°C.

- 580 Litres capacity
- White aluminium interior
- 3 x full size shelves & 1 x half shelf on refrigerators
6 x full size shelves & 1 x half shelf on freezers
- Lockable right-hand hinged door
- Digital thermometer display and controller
- Supplied with adjustable front feet, with rollers at the rear
- Incorporates energy efficient refrigerant
- Eco Design: Rating D, Climate Class 4, Normal Duty
- Manual defrost (Auto on freezer models)
- Operates in up to 30°C Ambient conditions



HED106



HED105



Glass Door Version
Available
- see page 250

Refrigerators (0°C to +8°C)

HED105 Refrigerator White Exterior Finish - 775 x 723 x 1840mm

HED106 Refrigerator Stainless Steel Exterior Finish - 775 x 723 x 1840mm

Freezers (-18°C to -22°C)

HED107 Freezer White Exterior Finish - 775 x 723 x 1840mm

HED108 Freezer Stainless Steel Exterior Finish - 775 x 723 x 1840mm



UPRIGHT REFRIGERATORS & FREEZERS

Medium Duty – Stainless Steel Upright Refrigerator & Freezer

A new range of medium duty gastronorm compatible upright cabinets, all stainless steel finish and representing outstanding value for money.

- 600 Litres capacity
- 2/1 GN Compatible
- Stainless steel interior & exterior
- Supplied with 3 x shelves/ 20 shelf positions
- Lockable right-hand hinged door
- Digital thermometer display and controller
- LED interior lighting
- Supplied with castors (two braked)
- Incorporates energy efficient refrigerant
- Eco Design: Rating D, Climate Class 4, Normal Duty
- Auto defrost
- Operates in up to 30°C Ambient conditions



FEATURES



All Stainless Steel
Interior/ exterior finish



Climate Class 4



LED
Interior Lighting



Fully Supported
2 year warranty

Refrigerator (+2°C to +8°C)

HEF136 Refrigerator Stainless Steel Exterior Finish - 680 x 810 x 2010mm

Freezer (-15°C to -20°C)

HEF137 Freezer Stainless Steel Exterior Finish - 680 x 810 x 2010mm



UPRIGHT REFRIGERATORS & FREEZERS

Medium Duty – Stainless Steel Upright Refrigerator & Freezer

A new range of medium duty gastronorm compatible upright cabinets, all stainless steel finish and representing outstanding value for money.

- 1200 Litres capacity
- 2/1 GN Compatible
- Stainless steel interior & exterior
- Supplied with 3 x shelves/ 20 shelf positions per door section
- Lockable doors
- Digital thermometer display and controller
- LED interior lighting
- Supplied with castors (two braked)
- Incorporates energy efficient refrigerant
- Eco Design: Refrigerator: Rating E, Climate Class 4, Normal Duty
Freezer: Rating D, Climate Class 4, Normal Duty
- Operates in up to 30°C Ambient conditions



FEATURES



All Stainless Steel
Interior/ exterior finish



Climate Class 4



LED
Interior Lighting



Fully Supported
2 year warranty

Refrigerator (+2°C to +8°C)

HEF544 Refrigerator Stainless Steel Exterior Finish - 1340 x 810 x 2010mm

Freezer (-15°C to -20°C)

HEF545 Freezer Stainless Steel Exterior Finish - 1340 x 810 x 2010mm



UPRIGHT REFRIGERATORS & FREEZERS

Heavy Duty – Stainless Steel Upright Refrigerators & Freezers

The Arctica Heavy Duty cabinets are some of most energy efficient cabinets in the UK market. These units are ideal for any busy commercial kitchen environment and they operate in ambient temperatures up to 40°C. Fully supported with a full on-site 3 year warranty.

- 2/1 GN Compatible
- Stainless steel interior & exterior
- Supplied with 3 x shelves/18 shelf positions
- Lockable right-hand hinged door
- Digital thermometer display and controller
- LED interior lighting
- Supplied with castors (two braked)
- Incorporates energy efficient refrigerant
- Eco Design: Rating B, Climate Class 5, Heavy Duty
- Auto defrost
- Operates in up to 40°C Ambient conditions



HED237



HED236

Refrigerators (0°C to +8°C)

HED235 Refrigerator Single Door 730 x 805 x 2065mm – 670 Litres Capacity

HED237 Refrigerator Double Door 1314 x 805 x 2065mm - 1240 Litres capacity

Freezers (-17°C to -22°C)

HED236 Freezer Single Door 730 x 805 x 2065mm - 670 Litres capacity

HED238 Freezer Double Door 1314 x 805 x 2065mm - 1240 Litres capacity



REFRIGERATED PREPARATION COUNTERS

Heavy Duty – Refrigerated Plain Top Preparation Counters

The Arctica Heavy Duty preparation counters are some of the most energy efficient counters in the UK market. These units are ideal for any busy commercial kitchen environment and they operate in ambient temperatures up to 40°C. Fully supported with a full on-site 3-year warranty.

- 1/1 GN Compatible
- Stainless steel interior & exterior
- Supplied with 1 x shelves/9 shelf positions per door section
- Digital thermometer display and controller
- Supplied with castors (front braked)
- Incorporates energy efficient refrigerant
- Eco Design: Rating A, Climate Class 5, Heavy Duty
- Auto defrost
- Operates in up to 40°C Ambient conditions



HED496



HED497



HED498

FULLY SUPPORTED
3 YEAR
WARRANTY

3
YEAR
WARRANTY

FEATURES



All Stainless Steel
Interior/ exterior finish



Climate Class 5
Designed to operate
in high ambient conditions



Fully Supported
3 year warranty

Preparation Counters (0°C to +8°C)

HED496 Preparation Counter 2 Door, 280 Litres capacity - 1360 x 700 x 840mm

HED497 Preparation Counter 3 Door, 420 Litres capacity - 1795 x 700 x 840mm

HED498 Preparation Counter 4 Door, 560 Litres capacity - 2230 x 700 x 840mm



3
YEAR
WARRANTY

REFRIGERATED PREPARATION COUNTERS

Heavy Duty – Refrigerated Plain Top Preparation Counters with Upstands

The Arctica Heavy Duty preparation counters are some of the most energy efficient counters in the UK market. These units are ideal for any busy commercial kitchen environment and they operate in ambient temperatures up to 40°C. Fully supported with a full on-site 3-year warranty.

- 1/1 GN Compatible
- Stainless steel interior & exterior
- 100mm Upstand to rear
- Supplied with 1 x shelves/9 shelf positions per door section
- Digital thermometer display and controller
- Supplied with castors (front braked)
- Incorporates energy efficient refrigerant
- Eco Design: Rating A, Climate Class 5, Heavy Duty
- Auto defrost
- Operates in up to 40°C Ambient conditions



FULLY SUPPORTED
3 YEAR
WARRANTY



FEATURES



All Stainless Steel
Interior/ exterior finish



Climate Class 5
Designed to operate
in high ambient conditions



Fully Supported
3 year warranty

Preparation Counters (0°C to +8°C)

HEF140 Preparation Counter With Upstand 2 Door, 280 Litres capacity - 1360 x 700 x 940mm

HEF141 Preparation Counter With Upstand 3 Door, 420 Litres capacity - 1795 x 700 x 940mm



REFRIGERATED PREPARATION COUNTERS

Refrigerated Compact Preparation Counters

The Arctica compact preparation counters are ideal where space is at a premium. With a stainless-steel worktop and refrigerated section below, your ingredients are close to hand.

- Stainless steel interior & exterior
- Supplied with 1 x shelf/2 shelf positions per door section
- Digital thermometer display and controller
- Visual alarm
- Supplied on castors as standard
- Incorporates energy efficient refrigerant
- Eco Design: Rating A, Climate Class 4, Normal Duty
- Auto defrost
- Operates in up to 30°C Ambient conditions.



HED499



HED500

Compact Preparation Counters (+2°C to +8°C)

HED499 Compact Preparation Counter 2 Door, 300 Litres capacity - 900 x 700 x 943mm

HED500 Compact Preparation Counter 3 Door, 380 Litres capacity - 1365 x 700 x 943mm



REFRIGERATED SALADETTE PREPARATION COUNTERS

Refrigerated Saladette Preparation Counters

These counter units provide refrigerated storage below, with easy access to chilled ingredients above. The top section allows the flexibility to add GN containers, compete with drop down lid for overnight storage and polypropylene prep work surface at the front of the counter.

- Stainless steel interior & exterior
- Digital thermometer display and controller
- Supplied with 2 x shelf/4 shelf positions per door section
- Drop-down stainless steel lid
- Polypropylene work surface to front of counter
- Temperature range +2°C to +8°C
- Supplied on castors as standard

*Note GN Containers not included



HEF568



HEF569

Saladette Counters (+2°C to +8°C)

HEF568 Saladette Preparation Counter 2 Door, 7 x 1/3 GN & 1 x 1/6 GN - 900 x 700 x 950mm

HEF569 Saladette Preparation Counter 3 Door, 12 x 1/3 GN - 1380 x 700 x 950mm



REFRIGERATED PIZZA PREPARATION COUNTERS

Refrigerated Pizza Preparation Counters

These counter units provide refrigerated storage below, with space on the top of the unit for gastronorm pans. This allows for a variety of toppings/fillings to be kept within easy reach.

- Stainless steel interior & exterior
- Digital thermometer display and controller
- Supplied with 1 x shelf/2 shelf positions per door section
- Covered prep top unit is ambient storage only
- Prep top unit: Capacity 5 x 1/6 GN or 7 x 1/3 GN up to 100mm deep (not included)
- Temperature range +2°C to +8°C
- Supplied on castors as standard

*Note GN Containers not included



HEF570

Pizza Counters (+2°C to +8°C)

HED501 Pizza Preparation Counter 2 Door, 5 x 1/6 GN - 900 x 700 x 1105mm

HEF570 Pizza Preparation Counter 3 Door, 7 x 1/3 GN - 1365 x 700 x 1105mm



REFRIGERATED PREPARATION COUNTERS

Refrigerated 4 & 6 Drawer Compact Preparation Counters

These counter units provide refrigerated drawer storage below, with a stainless-steel work surface on top.

- Stainless steel interior & exterior
- Drawers accept GN 1/1 Containers
- Digital thermometer display and controller
- Temperature range +2°C to +8°C
- Supplied on castors as standard
- Note GN Containers not included



HEF960

Compact Preparation Counters (+2°C to +8°C)

HEF959 4 Drawer Compact Preparation Counters - 900 x 700 x 943mm

HEF960 6 Drawer Compact Preparation Counters - 1365 x 700 x 943mm



REFRIGERATED PREPARATION TOPS

Refrigerated Preparation Tops with Glass Sneeze Screen

Ideal for holding pizza toppings, sandwich fillings or any other chilled ingredients you need quick access to.

- Stainless steel interior and exterior
- Glass sneeze guard (Requires self-assembly)
- Digital temperature display and controller
- Temperature range 0°C to +2°C
- Note GN Containers not included

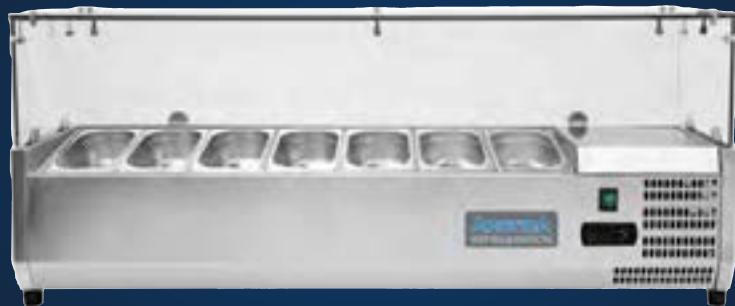

HEF966

Refrigerated Preparation Tops with Stainless Steel Cover

Ideal for holding pizza toppings, sandwich fillings or any other chilled ingredients you need quick access to.

- Stainless steel interior and exterior
- Hinged stainless steel lid
- Digital temperature display and controller
- Temperature range 0°C to +2°C
- Note GN Containers not included



HEF964

Refrigerated Preparation Tops

HEF965 With Glass Sneeze Screens 5 x 1/4 GN - 1205 x 335 x 465mm

HEF966 With Glass Sneeze Screens 7 x 1/4 GN - 1605 x 335 x 465mm

HEF963 With Stainless Steel Cover 5 x 1/4 GN - 1205 x 335 x 300mm

HEF964 With Stainless Steel Cover 7 x 1/4 GN - 1605 x 335 x 300mm



CHEST FREEZERS

Chest Freezers

Perfect for all large frozen storage needs.

- Available in 3 sizes offering flexibility and large storage space of up to 568 Ltr
- Operating temperature range of -18°C to -22°C
- Operates in an ambient temperature of up to 25°C
- Fitted lock to keep contents secure
- Comes complete with internal storage basket
- Stainless steel lid
- Low energy refrigerant



HEC916

FULLY SUPPORTED
3 YEAR
WARRANTY



Chest Freezers (-18°C to -22°C)

HEC916 Chest Freezer 370 Ltr - 1270 x 755 x 840mm

HEC917 Chest Freezer 465 Ltr - 1530 x 755 x 840mm

HEC918 Chest Freezer 568 Ltr - 1810 x 755 x 840mm



3
YEAR
WARRANTY

BOTTLE COOLERS

Single Door & Double Door Bottle Coolers

The Arctica range of bottle coolers is perfect for the display of chilled drinks. These units are energy efficient, incorporating environmentally friendly refrigerant & internal LED lighting.

- Black metal exterior/Aluminium stippled interior
- Self-closing, double glazed lockable door(s)
- Supplied with 2 x shelves/4 shelf positions per door section
- Internal digital thermometer display and controller
- Internal LED illumination
- Incorporates energy efficient refrigerant
- Fan assisted cooling for rapid temperature recovery
- Auto defrost
- Operates in up to 30°C Ambient conditions



HEC814



HEC816



HEC818

FULLY SUPPORTED
3 YEAR
WARRANTY

3
YEAR
WARRANTY

Single Door (0°C to +10°C)

HEF971 Low Height - Hinged Door, Capacity up to 140 x 330ml bottles - 555 x 496 x 846mm

HEC814 Standard Height - Hinged Door, Capacity up to 168 x 330ml bottles - 555 x 496 x 892mm

Double Door (0°C to +10°C)

HEF972 Low Height - Hinged Doors, Capacity up to 218 x 330ml bottles - 865 x 496 x 846mm

HEC816 Standard Height - Hinged Doors, Capacity up to 262 x 330ml bottles - 865 x 496 x 892mm

HEC818 Standard Height - Sliding Doors, Capacity up to 262 x 330ml bottles - 865 x 512 x 892mm



Internal LED Illumination



Lockable Door(s)



Internal Digital Display
and Temperature Control



3
YEAR
WARRANTY

BOTTLE COOLERS

Triple Door Bottle Coolers

The Arctica range of bottle coolers is perfect for the display of chilled drinks. These units are energy efficient, incorporating environmentally friendly refrigerant & internal LED lighting.

- Black metal exterior/Aluminium stippled interior
- Self-closing, double glazed lockable door(s)
- Supplied with 2 x shelves/4 shelf positions per door section
- Internal digital thermometer display and controller
- Internal LED illumination
- Incorporates energy efficient refrigerant
- Fan assisted cooling for rapid temperature recovery
- Auto defrost
- Operates in up to 30°C Ambient conditions



Internal LED Illumination



Lockable Door(s)



Internal Digital Display and Temperature Control



HEF970 - Sliding Door model



HEF969 - Hinged Door model

Triple Doors (0°C to +10°C)

HEF969 Standard Height - Hinged Doors, Capacity up to 452 x 330ml bottles - 1350 x 496 x 892mm

HEF970 Standard Height - Sliding Doors, Capacity up to 452 x 330ml bottles - 1350 x 512 x 892mm



UPRIGHT BOTTLE COOLERS

Upright Bottle Coolers

The Arctica upright coolers offer high capacity storage, with adjustable chrome shelves and attractive, low energy LED lighting. They are perfect for front of house display or bar areas, for maximising sales potential.

- Black stelvete exterior, stainless steel interior
- Hinged, lockable double-glazed door(s)
- 5 adjustable chrome shelves per door section
- Temperature range +2°C to +8°C
- LED interior lighting
- Digital thermometer display and controller
- Supplied with adjustable feet (not on castors)
- Auto defrost
- Operates in up to 30°C Ambient conditions



HEF546



HEF547

Bottle Coolers (+2°C to +8°C)

HEF546 Bottle Cooler 1 Door - Capacity up to 324 x 275ml bottles - 600 x 515 x 1815mm

HEF547 Bottle Cooler 2 Door - Capacity up to 492 x 275ml bottles - 920 x 515 x 1815mm



GLASS DOOR DISPLAY REFRIGERATOR

Glass Door Display Refrigerator

- 143 Litre capacity
- Temperature range 0°C to +8°C
- Lockable right-hand hinged double-glazed glass door
- White aluminium exterior casing and interior
- 2 x full size shelves and 1 x half shelf
- LED interior lighting
- Digital thermometer display and controller
- Supplied with adjustable front feet, with rollers at the rear
- Auto defrost
- Operates in up to 30°C Ambient conditions



Display Refrigerator (0°C to +8°C)

HEF540 Glass Door Display Refrigerator - 595 x 635 x 880mm



UPRIGHT DISPLAY REFRIGERATORS

Upright Display Refrigerators With Illuminated Canopy

Arctica upright display refrigerators with illuminated top panel are ideal for beverage merchandising. Features include double glazed doors, LED internal lighting and high storage capacity.

- Aluminium exterior casing and interior
- LED interior lighting/canopy
- Digital thermometer display and controller
- Auto defrost
- Operates in upto 30°C ambient conditions



Also available in White



HEF958

Double Door Models (Sliding) (+2°C to +10°C)

HEF956 880 Litres, white finish - 1295 x 695 x 2010mm

HEF958 880 Litres, black finish - 1295 x 695 x 2010mm



UPRIGHT DISPLAY REFRIGERATORS

Upright Display Refrigerators With Illuminated Canopy

Arctica upright display refrigerators with illuminated top panel are ideal for beverage merchandising. Features include double glazed doors, LED internal lighting and high storage capacity.

- Aluminium exterior casing and interior
- LED interior lighting/canopy
- Digital thermometer display and controller
- Auto defrost
- Operates in upto 30°C ambient conditions



HEF543



HEF957

Single Door Models (+2°C to +10°C)

HEF543 238 Litres, white finish - 555 x 540 x 1780mm

HEF957 278 Litres, black finish - 590 x 610 x 1905mm



UPRIGHT DISPLAY REFRIGERATORS

Upright Glass Door Display Refrigerators

These Arctica display refrigerators, are ideal for beverage merchandising or chilled food. Features include double glazed lockable door, LED internal lighting and high storage capacity.

- Temperature range 0°C to +8°C
- Lockable right-hand hinged double-glazed glass door
- White aluminium exterior casing and interior
- 3 x full size shelves and 1 x half shelf
- LED interior lighting
- Digital thermometer display and controller
- Supplied with adjustable front feet, with rollers at the rear
- Auto defrost
- Operates in up to 30°C Ambient conditions



HEF541



HEF542

Upright Display Refrigerators (0°C to +8°C)

HEF541 Upright Display Refrigerator 356 Litres - 595 x 653 x 1840mm

HEF542 Upright Display Refrigerator 580 Litres - 775 x 723 x 1840mm



BLAST CHILLER / FREEZERS

Blast Chiller/Freezers

Arctica blast chillers are simple to use. Quickly reduces the core temperature of products, whether they are cooked or fresh, conserving their fresh texture, hygiene, and quality, whilst reducing the risk of bacteria generating. It's a perfect appliance to help you adhere to food hygiene regulations.

- Cycle times: Blast chill cycle +70°C to +3°C in 90 minutes, Blast freeze cycle +70°C to -18°C in 240 minutes
- Stainless steel interior & exterior
- Accepts 1/1 GN trays (25mm deep) or 600mm x 400mm shelves (not supplied)
- Self-closing, right-handed door
- Digital controller with temperature display
- Built-in temperature probe
- Auto defrost
- Supplied on castors (2 braked)



HEF967



HEF968

Blast Chiller / Freezers

HEF967 20kg Chill Capacity / 15kg Freeze Capacity model - 800 x 800 x 1000mm

HEF968 40kg Chill Capacity / 15kg Freeze Capacity model - 800 x 800 x 1490mm





CHEFMASTER





CHEFMASTER

Chefmaster is a comprehensive range of kitchen appliances at highly competitive prices. From microwaves and contact grills to blenders and fryers, Chefmaster products are designed to maximise efficiency to food service and meet the needs of a demanding kitchen. In addition, Chefmaster products come with a 2-year warranty to give you that extra peace of mind. So you can be sure of Chefmaster's durability, performance and all this at an outstanding value for money.

WATER BOILERS - MANUAL FILL

278

TOASTERS

4 & 6 Slot Toasters

- Stainless steel finish
- Variable timer
- Removable crumb tray
- Variable slot selection
2 or 4 slots for HEA895
2, 4 or 6 slots for HEA896
- Manual lift mechanism
- Maximum bread size: 130 x 130 x 20mm



01



02

Conveyor Toaster

A conveyor toaster which combines both performance and superb value. Capable of up to 300 slices per hour. Simple and straightforward controls allow you to adjust the toasting speed and temperature for perfectly cooked toast.

- Double slot feed model
- Up to 300 slices per hour
- Maximum bread thickness 80mm
- Easy to load rack, with front or rear discharge
- Four position toast selector, including power save mode for quieter periods
- Includes blanking plate for control panel



03

01 HEA895 4 Slot Toaster - 300 x 250 x 215mm
02 HEA896 6 Slot Toaster - 400 x 250 x 215mm
AC8930 Spare Element

03 HE5071 Conveyor Toaster - 368 x 418 x 387mm
AC0900 Spare Lower Element
AC0901 Spare Upper Element



WAFFLE MAKER

Waffle Maker

- Stainless steel body
- Cast-iron plates
- Makes rectangle 4 x 6 square pattern waffles
- Adjustable temperature 50°C to 300°C
- Drip tray to the rear
- Fork included



HEB081 Waffle Maker - 461 x 322 x 222mm



2
YEAR
WARRANTY

CRÊPE MAKER

Crêpe Maker

- 400mm diameter cast-iron baking plate with non-stick coating
- Stainless steel housing
- Temperature range from 30°C to 300°C
- Built-in storage drawer
- Wooden spreader included



HEF572 Crêpe Maker - 450 x 510 x 240mm



2
YEAR
WARRANTY

CONTACT GRILLS

Contact Grills

These contact grills are available in 3 sizes and with a choice of various flat/ribbed plate options as detailed below.

- Robust, cast-iron plates
- Adjustable sprung top plate to prevent food from being crushed
- Thermostatically controlled, temperature range 50°C to 300°C (2 independent controls on double grill)
- Includes cleaning brush (excluding HEA788 & HEA790)



Ribbed Plate



Flat Plate



HEA750



HEA751

Small Single Grill

- Power: 1.8kw, 13 amp plug
- Grilling area: 218 x 230mm
- Dimension: 290 x 305 x 210mm

Large (Panini) Single Grills

- Power: 2.2kw, 13 amp plug
- Grilling area: 340 x 230mm
- Dimension: 410 x 305 x 210mm

Double Grills

- Power: 2 x 1.8kw, 2 x 13 amp plugs
- Grilling area: 475 x 230mm
- Dimension: 570 x 305 x 210mm

Small Single Grill

HEA773 Ribbed top/ribbed bottom plates

Large (Panini) Single Grills

HEA750 Ribbed top/flat bottom plates

HEA788 Flat top/flat bottom plates, no cleaning brush supplied

HEA787 Ribbed top/ribbed bottom plates

Double Grills

HEA751 Ribbed top/flat bottom plates

HEA790 Flat top/flat bottom plates, no cleaning brush supplied

HEA789 Ribbed top/ribbed bottom plates



GRIDDLES

Standard Width Griddle

- Flat steel griddle plate designed to ensure even heat distribution
- Front grease drawer
- Thermostatically controlled
- Temperature range 50°C to 300°C
- Cooking surface 550 x 350mm



01

01 HEA754 Standard Width Griddle - 550 x 430 x 240mm

Extra Wide Griddle

- Flat steel griddle plate designed to ensure even heat distribution
- Dual temperature zones with individual controls
- Front grease drawer
- Thermostatically controlled
- Temperature range 50°C to 300°C
- Cooking surface 728 x 400mm



02

02 HEF573 Extra Wide Griddle - 730 x 530 x 230mm



BAIN-MARIES

1/1 GN Compatible Bain-Maries

A range of wet heat bain-maries, perfect for keeping pre-cooked food products ready to serve.

- Accepts GN containers up to 150mm deep
- Wet heat only application
- Includes “boil dry” safety cut out switch
- Models available with or without drain off tap and with or without containers
- Models with containers are supplied with 2 x 1/3 GN's, 2 x 1/6 GN's, Lids and adaptive bars



HEF575



HEA758



HEF576



HEF577

HEF575 1/1 GN Bain-Marie
- 355 x 555 x 255mm

HEF576 1/1 GN Bain-Marie c/w containers
- 355 x 555 x 255mm

HEA758 1/1 GN Bain-Marie c/w drain off tap
- 355 x 555 x 255mm

HEF577 1/1 GN Bain-Marie c/w drain off tap & containers
- 355 x 555 x 255mm



BARBECUE - FOLDING

Folding Barbecue

- Piezo ignition
- Stand mounted on wheels
- Stainless steel body/foldable chrome plated legs
- Supplied with gas hose and regulator 50mb propane gas
- LPG operated - requires a 5kg or 11kg bottle (not supplied)
- Total grilling area 870mm x 290mm
- For outdoor use only



HE1281 Folding Barbecue - 1120 x 420 x 900mm



2
YEAR
WARRANTY

FRYERS - COUNTERTOP

Countertop Electric Fryers

- Stainless steel construction with stainless steel lids
- Thermostatic control with safety cut-out switch
- Max temperature 190°C
- Non-slip rubber feet



01

4 Ltr Single Basket Model

- Single tank/single basket
- Up to 4.2kg (9.3lbs) frozen chips per hour
- Up to 4.8kg (10.8lbs) non-frozen chips per hour
- Power 2kw



02

6 Ltr Single Basket Model

- Single tank/single basket
- Up to 6.4kg (14lbs) frozen chips per hour
- Up to 7.2kg (16lbs) non-frozen chips per hour
- Power 2.5kw



03

2 x 6 Ltr Twin Tank Model

- Twin tanks/single basket per tank
- Up to 2 x 6.4kg (2 x 14lbs) frozen chips per hour
- Up to 2 x 7.2kg (2 x 16lbs) non-frozen chips per hour
- Power: 2 x 2.5kw, 2 x 13 amp plugs

01 HED242 4 Ltr Single Basket Model - 217 x 400 x 320mm

02 HEA752 6 Ltr Single Basket Model - 265 x 430 x 295mm

03 HEA753 2 x 6 Ltr Twin Tank Model - 550 x 430 x 295mm



PIZZA OVEN

Single Deck Pizza Oven

- Stainless steel construction
- Stone baking deck
- Air vent with shutter
- Capacity 2 x 220mm (8³/₄") pizzas
- Power: 1.6kw



HEB070 Single Deck Pizza Oven - 580 x 490 x 245mm



2
YEAR
WARRANTY

INDUCTION HOBS

3kw Single Zone

- Stainless steel body with black glass ceramic top
- 10 power settings
- Temperature range 60°C - 240°C
- Touch control panel & LED display
- 180 minutes timer
- Suitable for pan sizes 12 - 26cm



01

2kw Single Zone

- Plastic body with black glass top
- 10 power settings
- Temperature range 60°C - 240°C
- Touch control panel & LED display
- 180 minute timer
- Suitable for pan sizes 12 - 26cm



02

3kw Double Zone

- Plastic body with black glass top
- 10 power settings
- Temperature:
Left hand side 60°C - 240°C,
500-1800w
Right hand side 60°C-240°C,
500-1300w
- Touch control panel & LED display
- 180 minute timer
- Suitable for pan sizes 12 - 24cm



03

01 HEA774 3kw Single Zone - 340 x 445 x 120mm

02 HEA516 2kw Single Zone - 291 x 355 x 65mm

03 HEA517 3kw Double Zone - 605 x 360 x 66mm



MICROWAVES

1000 Watt Microwave

- Stainless steel interior & exterior
- 25 Ltr cavity
- Touch controls
- 100 programmes
- 3 cooking stages
- 2 x multiple quantity setting
- 10 power levels
- Up to 60 minute timer
- Internal dimensions 327 x 346 x 200mm



01

1800 Watt Heavy Duty Microwave

- Stainless steel interior/exterior
- 34 Ltr cavity
- Touch controls
- 100 programmable options/10 power levels
- 3 Stage cooking
- 2x quantity cooking function
- Internal light
- Internal dimensions 360 x 408 x 224mm



02

01 HEB082 1000 Watt Microwave - 511 x 432 x 311mm

02 HEB643 1800 Watt Heavy Duty Microwave - 575 x 529 x 368mm



2
YEAR
WARRANTY

CONVECTION OVEN

4 Shelf Convection Oven with Grill

This high-powered oven offers the flexibility of pre-heat, convection, grill and steam functionality.

- Stainless steel finish, easy to clean
- Digital touchscreen panel
- Built in humidifier, offering steam function
- Internal grill function
- Cook & Hold facility
- Fan assisted oven with easy-to-use icon-driven menu selections
- Offers multi-stage programmable options & manual cooking
- 4 Shelves positions (4 aluminium trays included)
- 99 Minute timer
- Internal light
- Drop down door with cool touch handle



HEC819 Convection Oven - 595 x 595 x 570mm



SLICERS

Medium Duty Slicers

These medium duty slicers are capable of delivering high volume performance at an exceptional value for money price and are ideal for restaurants, cafés, coffee shops and bars.

- Aluminium housing
- 0-12mm slice adjustment for precision slicing
- Built-in blade sharpener
- Safety locking system



HEC821 Medium Duty Slicer - 220mm Blade - 470 x 450 x 345mm

HEA759 Medium Duty Slicer - 250mm Blade - 510 x 445 x 385mm

HEB084 Medium Duty Slicer - 300mm Blade - 630 x 530 x 470mm



MIXERS - TABLETOP

5.5Ltr Table Top Mixer

An attractive, versatile and powerful table top mixer with a metal housing and easy to use dial controls.

- 5.5 Ltr stainless steel bowl
- Aluminium housing
- Powerful 1500 watt motor
- 6 speed dial including pulse function
- Supplied with flat beater, dough hook and balloon whisk
- Lift up head for easy tool change and bowl removal
- Safety cut-out when head is raised



01

01 HEA520 Table Top Mixer 5.5 Litre - 410 x 320 x 400mm

7Ltr Table Top Mixer

Ideal for smaller batches. Perfect for mixing, pastry & preparation of sauces.

- Complete with 7 litre stainless steel bowl, beater, dough hook & wire whisk
- Easy to use bowl lift provides easy access for cleaning
- Includes safety micro switch
- Grey metal construction



02

02 HEF574 Table Top Mixer 7 Litre - 236 x 403 x 438mm



MIXERS - HEAVY DUTY

Heavy Duty Mixers

A range of reliable & robust heavy duty mixers, perfect for all environments.

- All supplied with beater, dough hook & whisk
- Aluminium body
- Easy to use on/off buttons
- 3 speed gear box
- Safety guard with micro switch
- HEB633 & HEB634 should be sited on a low height mixer table (HEF655)

ACCESSORIES INCLUDED

DOUGH HOOK



BEATER



WHISK



- | | |
|--------|-------------------------------------------------------------|
| HEB632 | 10 Ltr Capacity Model Heavy Duty Mixer - 370 x 460 x 620mm |
| HEB633 | 20 Ltr Capacity Model Heavy Duty Mixer - 505 x 555 x 764mm |
| HEB634 | 30 Ltr Capacity Model Heavy Duty Mixer - 584 x 617 x 1136mm |
| HEB655 | Low Height Mixer Table - 600 x 600 x 550mm |



2
YEAR
WARRANTY

STICK BLENDERS

Light Duty Stick Blender

- 800watt motor
- A simple to use power control button, the harder you press, the faster it goes
- Removable shaft for easy cleaning
- Stainless steel shaft & blades
- Variable speed up to 13,000 rpm
- 160mm Shaft



01



WHEN ORDERING
SELECT MOTOR &
LENGTH OF SHAFT



02

Heavy Duty Stick Blender

3 inter-changeable shafts and a double whisk available (sold separately).

- High quality plastic handle
- Stainless steel shafts available in 3 lengths, 370mm, 450mm & 530mm
- Double whisk attachment also available
- Variable speed 3,000 - 12,000 rpm
- Powerful 750 watt motor
- Capacity from 50 - 100 Ltr

BLENDER SHAFTS (3 LENGTHS AVAILABLE) & WHISK
TO BE ORDERED SEPARATELY

370mm



03

450mm



04

530mm



05

Whisk



06

- 01 **HEB642** Light Duty Stick Blender
- 02 **HEA505** Heavy Duty Stick Blender Motor (Shaft & whisk not included)
- 03 **OE9766** 370mm Shaft For Heavy Duty Stick Blender (Up to 50Ltr capacity)

- 04 **OE9767** 370mm Shaft For Heavy Duty Stick Blender (Up to 75Ltr capacity)
- 05 **OE9768** 530mm Shaft For Heavy Duty Stick Blender (Up to 100Ltr capacity)
- 06 **OE9769** Whisk Attachment For Heavy Duty Stick Blender



VEGETABLE PREPARATION MACHINE

Vegetable Preparation Machine

The 550 watt highly efficient motor is designed for cutting large quantities of vegetables. An excellent cut is guaranteed due to the high quality discs. Equipped with a large and small inlet on top, ideal for most vegetables.

- Suitable for slicing, dicing, shredding and grating
- Die cast aluminium body
- Small and large hoppers
- **No Discs** included as standard



Large Chopping Blade



Feed Tube & Chopping Blade



Feed Tube

Preparation Machine (no discs)

HEF606 Vegetable Preparation Machine - 622 x 247 x 507mm



Cutting Discs • Stainless Steel

AC9872 2mm Slicing Blade

AC9871 4mm Slicing Blade

ACA433 8mm Slicing Blade

ACA432 10mm Slicing Blade

AC9870 3mm Grating Blade

AC9869 4mm Grating Blade

AC9868 7mm Grating Blade

ACA434 4mm x 4mm Julienne Blade

ACA435* 8mm x 8mm Dicing Grid

ACA436** 10mm x 10mm Dicing Grid

ACA437* 8mm French Fry Blade

ACA438** 10mm French Fry Blade

*Note ACA435/ACA437 require ACA433 8mm Slicing Disc to operate
 **Note ACA436/ACA438 require ACA432 10mm Slicing Disc to operate

INSECT CONTROL UNITS & FLY SCREEN

Insect Control Units

A range of models, suitable for all commercial kitchens. Encased in a metal frame, with a catchment tray. Uses energy efficient bulbs.

- High efficiency UV fluorescent bulb
- Can be wall mounted or ceiling suspended
- Easy to operate on/off switch
- Large and simple to remove insect collection tray
- Replacement bulb - order AC9709



01



02



03

Glue Board Insect Control Unit

Stylish wall mountable fly killer traps insects discreetly. High quality UV with a coverage of 50m².

- High efficiency UV-A tube
- ABS fireproof plastic housing
- 50m² coverage
- Glue board (replace once a month) - order ACA275
- Replacement bulb - order ACA274



04

Fly Screen

Provides an effective barrier, preventing insects from entering food premises.

- Easy clean aluminium
- Attractive silver finish
- Fits doors up to 1000mm x 2000mm
- Can be cut to size required



05

01 **HEA780** 50m² Coverage 1 x 11 watt UV fluorescent bulb - 340 x 100 x 265mm
02 **HEA782** 100m² Coverage 2 x 11 watt UV fluorescent bulb - 335 x 100 x 265mm
03 **HEA784** 150m² Coverage 3 x 11 watt UV fluorescent bulb - 490 x 100 x 265mm

04 **HEF217** Glue Board Insect Control Unit - 375 x 140 x 196mm
05 **HEA786** Fly Screen - 1000 x 2000mm



CARVING KNIFE - ELECTRIC

Electric Carving Knife

Professional electric carving knife.

- Single speed
- Once located in motor unit, blade length 190mm (from tip to guard), 170mm of which is serrated
- 2 metre cable
- 95 watt motor



HEA841 Electric Carving Knife



2
YEAR
WARRANTY

SOUP KETTLES

6 Litre Soup Kettles

- Choice of black metallic or mirror polished stainless steel finish
- 6 litre capacity
- Wet heat operation
- Temperature range 30°C to 95°C
- Removable inner container for easy cleaning
- Hinged, removable stainless steel lid with ladle cut out



01

02

10 Litre Soup Kettles

- Cauldron style self service unit
- Choice of black metallic or mirror polished stainless steel finish
- 10 litre capacity
- Wet heat operation
- Re-heated operation - adjustable simmerstat
- Removable inner container for easy cleaning
- Hinged stainless steel lid



03

04



01 HEA776 6 Litre Soup Kettle - 280 dia x 370mm - Black Finish
02 HEA777 6 Litre Soup Kettle - 280 dia x 370mm - Stainless Steel Finish

03 HED233 10 Litre Soup Kettle - 345 dia x 349mm - Black Finish
04 HED232 10 Litre Soup Kettle - 345 dia x 349mm - Stainless Steel Finish



2
YEAR
WARRANTY

PIE CABINETS

Pie Cabinets

- Stainless steel construction with toughened glass
- Sliding glass doors to rear and fixed glass panel to front
- Variable temperature control 30°C – 90°C
- Visible temperature display
- Removable crumb tray
- Supplied with removable shelves - 4 for HEC823, 5 for HEC824



01



02



01 HEC823 Pie Cabinet - 640 x 360 x 530mm

02 HEC824 Pie Cabinet - 865 x 360 x 625mm



2
YEAR
WARRANTY

RICE COOKER & RICE WARMER

5.4 Litre Rice Cooker / Warmer

- 5.4 Ltr capacity – Holds up to 14 Ltr cooked rice
- Auto keep warm after cooking has finished
- Removable non-stick inner for easy cleaning
- Supplied with measuring cup & spatula



01

20 Litre Rice Warmer

- 20 Ltr capacity
- Warmer function only
- Removable non-stick liner for easy cleaning
- Includes spatula



02

01 HEB640 5.4 Litre Rice Cooker - 480 dia x 335mm

02 HEB641 20 Litre Rice Warmer - 480 dia x 385mm



WARMING LAMPS

Warming Lamps

- Choice of Single or Double
- Adjustable heads for easy movement
- Independent on/off switch for each head
- Power 250watt per bulb
- Spare bulb OEA147

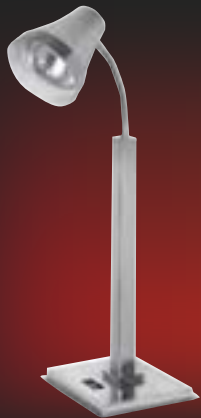

01

Stainless steel
base



02

Stainless steel
base



03

Marble
base

Food Warmer

- Lightweight aluminium frame for ease of movement
- 2 x 275w bulbs which provide heat & light
- Simply on/off toggle switch
- Accepts 1/1 GN pans
- Spare bulb AC8920



04



- 01 HED492 Warming Lamp - 290 x 250 x 700mm
- 02 HED493 Warming Lamp - 380 x 250 x 700mm
- 03 HED494 Warming Lamp - 400 x 270 x 700mm

- 04 HEA887 Food Warmer - 490 x 355 x 610mm



HEATED DISPLAY BASES

Heated Display Bases

- Aluminium frame with tempered black glass
- Adjustable temperature up to 95°C



01



02

Heated Display Unit

- Stainless steel construction with heated black glass base
- Twin infrared bulbs for both heat and light (150watt)
- Adjustable temp 30°C – 85°C
- Independent controls for each side
- Accepts 2 x 1/1 GN pans



03

01 HEA794 Heated Display Base - Usable area 500 x 300mm - Overall dims 570 x 305 x 40mm

02 HEA795 Heated Display Base - Usable area 600 x 500mm - Overall dims 670 x 505 x 40mm

03 HED240 Heated Display Unit - 730 x 580 x 550mm



WATER BOILERS - MANUAL FILL

Manual Fill Water Boilers

Ideal for use in locations with no plumbed water.

- Thermostatic control with automatic cut-off
- Polished stainless steel body
- 'Water ready' indicator light
- Illuminated 'power-on' switch
- Auto reset and boil dry protection



- | | | |
|----|--------|-----------------------------------------------------|
| 01 | HEA755 | Manual Fill Boiler 10 Litre Model - 210 dia x 475mm |
| 02 | HEA756 | Manual Fill Boiler 20 Litre Model - 268 dia x 600mm |
| 03 | HEA757 | Manual Fill Boiler 30 Litre Model - 385 dia x 500mm |

2
YEAR
WARRANTY

WATER BOILER - AUTO FILL

28 Litre Hourly Output Autofill Countertop Water Boiler

The Chefmaster autofill water boiler provides a high capacity 28 litre output, combined with a rapid 8 litres of boiling water available for immediate draw-off.

- Stainless steel outer casing
- 8 Litre draw-off/28 Litre output per hour
- Advanced LED temperature display
- Variable temperature setting - adjust between 60°C and 97°C as required
- Indicates when filter cartridge needs replacing. Supplied with 1 x filter cartridge
- Tap height position 240mm from drip tray - allows filling of larger vessels
- Insulated tank - ensuring lower energy consumption
- Removable drip tray



LED Temperature Display



Inbuilt Easy Change Water Filter



240mm Tap height for filling of larger vessels

HEF605 Automatic Water Boiler 28 Litre - 200 x 436 x 589mm

OEA313 Replacement filter cartridge



2
YEAR
WARRANTY

COFFEE PERCOLATOR

15 Litre Capacity Coffee Percolator

Stainless steel coffee percolator, with double-wall to help retain temperature and lower energy consumption.

- Built-in filter for coarsely ground coffee
- Easy to read glass water level gauge
- Descaling indicator
- Welded stainless steel handles with silicone grip
- Removable drip tray with stainless steel grid



HEF571 Coffee Percolator 15 Litre Capacity - 386 x 393 x 641 mm



2
YEAR
WARRANTY

COFFEE MACHINES

1.8 Ltr Filter Coffee Machine

- 2 individually switched hotplates
- Supplied with a 1.8 Ltr shatterproof jug
- Brewing time approx. 7 minutes/1 jug
- Output approx. 16 Ltr per hour
- Robust stainless steel construction
- Manual fill
- Capacity: 1.8 Ltr/7min, 16 Ltr/hr

2.0 Ltr Filter Coffee Machine

- Brews fresh coffee direct into a flask
- Supplied with a stainless steel double wall 2.0 Ltr vacuum jug
- Brewing time approx. 8 minute/1 jug
- Output approx. 15 Ltr per hour
- Manual fill
- Capacity: 2.0Ltr/8min, 15 Ltr/hr



Coffee Jug Hotplates

- 2 individually switched 130mm dia Hotplates



01 HEB085 1.8 Ltr Filter Coffee Machine - 215 x 410 x 460mm

02 HEB086 2.0 Ltr Filter Coffee Machine - 210 x 410 x 520mm

03 HEB087 Coffee Jug Hotplates - 355 x 180 x 70mm



2
YEAR
WARRANTY

BLENDERS - BAR

2 Ltr Blenders

- Ideal for preparing ice drinks, cocktails and smoothies
- Available in Manual or Programmable controller options
- 2Ltr polycarbonate jug included
- 3 horse power motor

- **HEC825** - Includes timer function plus 4 variable speed settings & pulse button

- **HEC826** - Simple On/Off switch plus low to high variable speed controller & pulse switch



01

02

1.5Ltr Blender with Sound Enclosure

- Ideal for preparing ice drinks, milkshakes and smoothies
- 1.5Ltr Polycarbonate jug included
- Digital controller
- 3 horse power motor
- 4 speed settings:
15,000 / 20,000 / 25,000 / 30,000 rpm
- Pulse button



03

01 **HEC825** 2 Ltr Blender with Programmable Controls - 230 x 254 x 492mm

02 **HEC826** 2 Ltr Blender with Manual Controls - 252 x 255 x 520mm

03 **HED244** 1.5Ltr Blender with Sound Enclosure - 230 x 254 x 492mm



2
YEAR
WARRANTY

JUICER - AUTOMATIC

Automatic Juicer

- Perfect for making batches of fruit and vegetable juice
- Powerful 700 watt motor
- 3000 rpm speed for consistent juicing
- 80mm wide chute
- 7.5 Ltr pulp container



HEA873 Automatic Juicer - 257 x 473 x 522mm



2
YEAR
WARRANTY

AIR POTS & BEVERAGE JUGS

Pump Air Pots

Plain Models

Easy-to-use, one hand push button pump dispenser with unbreakable stainless steel interior and exterior, safety lock and leakage protection spout.



Pump Air Pots

Inscribed Models

A choice of 3 indelible inscriptions, COFFEE, TEA and HOT WATER, to eliminate taste contamination.



- 01 **DM265** 1.9 Litre Pump Air Pot - Plain
- 02 **DF140** 2.5 Litre Pump Air Pot - Plain
- 03 **DF141** 3 Litre Pump Air Pot - Plain
- 04 **DF142** 5 Litre Pump Air Pot - Plain

- 05 **DF143** 3 Litre Pump Air Pot - TEA
- 06 **DF144** 3 Litre Pump Air Pot - COFFEE
- 07 **DM266** 3 Litre Pump Air Pot - DECAF
- 08 **DF145** 3 Litre Pump Air Pot - HOT WATER



AIR POTS & BEVERAGE JUGS

Vacuum Beverage Jugs

Unbreakable stainless steel inner lining keeps drinks hot or cold for hours.

- Thumb release mechanism



01



02



03

Inscribed Vacuum Jugs

Designed to keep beverages at the desired temperature, ideal for serving beverages throughout your service times. Double walled insulated construction.

- Thumb release mechanism



04



06



08



05



07

- 01 **DM259** 1 Litre Vacuum Beverage Jug - Plain
- 02 **DF149** 1.5 Litre Vacuum Beverage Jug - Plain
- 03 **DF148** 2 Litre Vacuum Beverage Jug - Plain

- 04 **DM260** 1 Litre Inscribed Vacuum Jug - MILK
- 05 **DM261** 1.5 Litre Inscribed Vacuum Jug - TEA
- 06 **DM262** 1.5 Litre Inscribed Vacuum Jug - COFFEE
- 07 **DM263** 1.5 Litre Inscribed Vacuum Pot - DECAF
- 08 **DM264** 1.5 Litre Inscribed Vacuum Jug - HOT WATER



AIR POTS & BEVERAGE JUGS

Deluxe Vacuum Jugs

Brushed stainless steel jug with contrasting mirror finish lid and handle. Flip-top lid for steady, spill-free pouring.



Vacuum Beverage Jugs

Constructed inside and out from stainless steel giving excellent thermal retention. Black ABS handle, neck & lid.

- Removable screw top lid with pouring lever

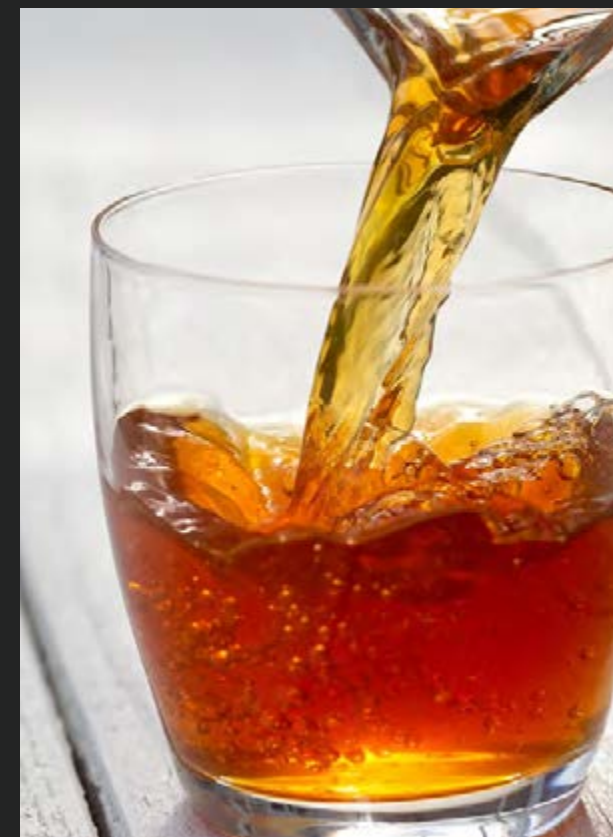

- 01 **DF146** 1 Litre Deluxe Vacuum Jug - Plain
- 01 **DF147** 2 Litre Deluxe Vacuum Jug - Plain
- 02 **DK484** 1 Litre Deluxe Vacuum Jug - TEA
- 03 **DK485** 1 Litre Deluxe Vacuum Jug - COFFEE
- 04 **DK486** 1 Litre Deluxe Vacuum Jug - HOT WATER

- D4067** 1 Litre Vacuum Beverage Jug - Plain
- D4068** 1.5 Litre Vacuum Beverage Jug - Plain
- D4069** 2 Litre Vacuum Beverage Jug - Plain



The logo for CONNECTA features a stylized teal and dark grey icon on the left, followed by the word "CONNECTA" in a bold, sans-serif font. The "CON" is teal, and "NECTA" is dark grey.

The logo for CONNECTA, featuring a teal square icon with a white cross-like shape inside, followed by the word "CONNECTA" in a bold, black, sans-serif font.

Connecta is a collection for any catering and hospitality environment with its high quality range of stainless steel tables, sink units, wash basins, shelving units and trolleys.

Every product comes with a superb finish to provide durability. Connecta is highly functional, fit for purpose and easy to assemble. All Connecta items come with a 2-year warranty.

Purpose-built, practical and great value for money.

That's **CONNECTA!**

STAINLESS STEEL TABLES

Stainless Steel Tables

This range of table units combines a high-quality finish of all stainless-steel construction with a full-length undershelf that provides additional storage space.

- All stainless-steel construction, including full-length stainless-steel undershelf
- Working surface at 900mm
- 100mm upstand to rear - Wall Tables only
- Fitted with adjustable feet for on site levelling
- Top - 201 Grade stainless steel
Frame - 201 Grade tubular stainless steel
Undershelf - 201 Grade stainless steel
- Supplied flat-packed - self-assembly required
- Castors available to purchase separately - order HEF654



100mm Boxed upstand on wall tables



HEF646



HEF651

Wall Tables

HEF644	600 x 600 x 1000mm
HEF645	900 x 600 x 1000mm
HEF646	1200 x 600 x 1000mm
HEF647	1500 x 600 x 1000mm
HEF648	1800 x 600 x 1000mm

Centre Tables

HEF649	600 x 600 x 900mm
HEF650	900 x 600 x 900mm
HEF651	1200 x 600 x 900mm
HEF652	1500 x 600 x 900mm
HEF653	1800 x 600 x 900mm

Accessories

HEF654	Set of 4 Castors - 2 Braked
--------	-----------------------------



LOW HEIGHT MIXER TABLE & FOLDING TABLES

Stainless Steel Table for Mixers

- All stainless-steel construction, including undershelf
- 50mm upstand to three sides
- Fitted with adjustable feet for on site levelling
- Top - 201 Grade stainless steel
Frame - 201 Grade tubular stainless steel
Undershelf - 201 Grade stainless steel
- Supplied flat-packed - self-assembly required



50mm Upstand
to three sides



HEF655



Hinged/Foldable legs
for ease of storage

Stainless Steel Folding Tables

These stainless steel folding tables are ideal when you need temporary extra worktop space - whether it's to prepare "food on the go" or when catering outdoors.

- All stainless-steel construction
- Fitted with adjustable feet for on-site levelling
- Supplied flat-packed - self-assembly required



HEF666

Low Height Table

HEF655 600 x 600 x 550mm

Folding Tables

HEF666 1200 x 600 x 850mm

HEF667 1800 x 600 x 850mm



STAINLESS STEEL BOWL SINK UNITS

Stainless Steel Bowl Sink Units

This range of sink units combines a high-quality finish of all stainless-steel construction with a full-length undershelf that provides additional storage space. These units are supplied as flatpack, for simple self-assembly.

- All stainless-steel construction, including full length undershelf
- Working surface at 900mm
- 100mm upstand to rear
- Supplied with standpipe(s) and waste fittings
- Fitted with adjustable feet for on site levelling
- Top - 201 Grade stainless steel
Frame - 201 Grade tubular stainless steel
Undershelf - 201 Grade stainless steel
Bowl Size - 500 x 400 x 250mm
- Supplied flat-packed - self-assembly required
- 1/2" Lever Arm mixer tap available to purchase separately - order OEA314



For Lever Arm Mixer Tap
- order OEA314



100mm Boxed upstand
on sink units



Bowl size
500 x 400 x 250mm



HEF722



HEF659

Single Bowl/Left Hand Drainer

HEF722 1000 x 600 x 1000mm

HEF657 1200 x 600 x 1000mm

Single Bowl/Right Hand Drainer

HEF721 1000 x 600 x 1000mm

HEF656 1200 x 600 x 1000mm

Double Bowl/Left Hand Drainer

HEF659 1500 x 600 x 1000mm

HEF661 1800 x 600 x 1000mm

Double Bowl/Right Hand Drainer

HEF658 1500 x 600 x 1000mm

HEF660 1800 x 600 x 1000mm



WASH HAND BASINS

Polycarbonate Standard Wash Hand Basin

- Grey ABS Polycarbonate finish
- Embedded anti-bacterial agent improves hygiene
- Includes pair of dome head taps, water hose and waste plug
- WRAS approved
- Bowl size 255 x 278 x 110mm deep



HEF717

Standard Wash Hand Basin

- Includes pair of 3" lever taps, water hose and waste plug
- WRAS approved
- Bowl size 240mm dia x 135mm deep



HEF718

Hands-Free Wash Hand Basin

- Push front hands-free operation
- Includes fixed spout manual mixer tap, water hose and waste plug
- WRAS approved
- Bowl size 260mm dia x 150mm deep



HEF716

HEF717 Polycarbonate Standard Wash Hand Basin - 355 x 320 x 195mm

HEF718 Standard Wash Hand Basin - 305 x 270 x 140mm

HEF716 Hands-Free Wash Hand Basin - 300 x 320 x 190mm



STAINLESS STEEL WALL SHELVES

Stainless Steel Wall Shelves

- Constructed from 201 Grade stainless steel
- Max. weight of 25kg per linear metre
- Pre-drilled box section brackets included
- Supplied flat-packed - self-assembly required



Stainless Steel Wall Shelves

HEF662 600 x 300mm

HEF664 1200 x 300mm

HEF663 900 x 300mm

HEF665 1500 x 300mm



4 TIER CHROME WIRE SHELVING UNITS

4 Tier Chrome Wire Shelving Units

Suitable for use in dry store, display/retail, archive/office and linen/laundry usage. Not for use in chilled or wet areas.

- Bright chrome wire shelves and 25mm dia. uprights, grooved at 25mm increments
- 4 Tier modules - 1800mm high
- Maximum load capacity: 900/1200mm = 300kg per shelf, 1500mm = 275kg per shelf - if fitted on castors this reduces to maximum 300kg per shelving module
- Supplied with adjustable non-marking plastic feet as standard
- Supplied flat-packed - self-assembly required
- Castors available to purchase separately - order OEA319

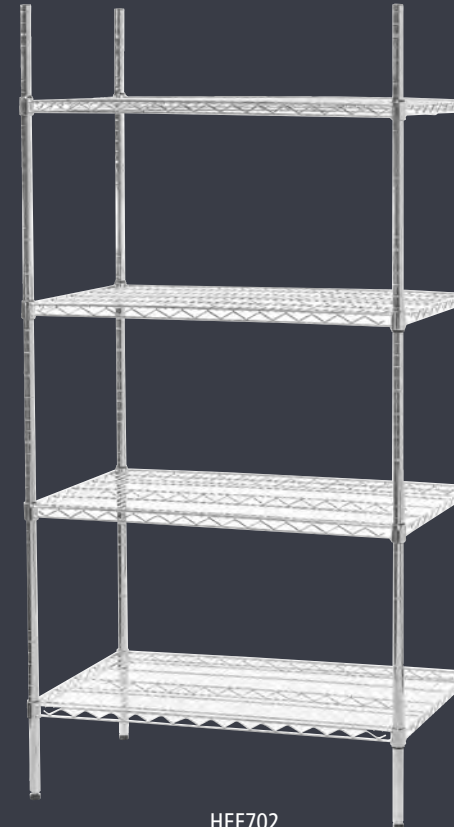

HEF702

Chrome Wire Shelving Units

HEF699 4 Tier - 900 x 400 x 1800mm

HEF700 4 Tier - 1200 x 400 x 1800mm

HEF701 4 Tier - 1500 x 400 x 1800mm

HEF702 4 Tier - 900 x 600 x 1800mm

HEF703 4 Tier - 1200 x 600 x 1800mm

HEF704 4 Tier - 1500 x 600 x 1800mm



4 TIER NYLON COATED WIRE SHELVING UNITS

4 Tier Nylon Coated Wire Shelving Units

As well as being suitable for use in dry store areas, these versatile and highly durable shelving units can also be used in chiller/freezer, wet storage, chemical and kitchen/pot wash areas.

- Grey nylon coated wire shelves and 25mm dia. Grey nylon coated uprights, grooved at 25mm increments
- 4 Tier modules - 1800mm high
- Maximum load capacity: 900/1200mm = 300kg per shelf, 1500mm = 275kg per shelf - if fitted on castors this reduces to maximum 300kg per shelving module
- Supplied with adjustable non-marking plastic feet as standard
- Temperature tolerant from -42°C to +110°C
- Supplied flat-packed - self-assembly required
- Castors available to purchase separately - order OEA319

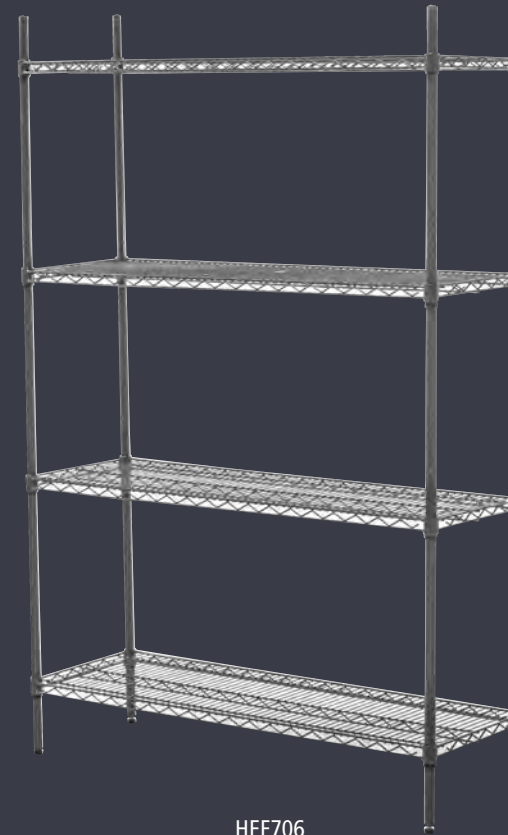

HEF706

Nylon Coated Wire Shelving Units

HEF705 4 Tier - 900 x 400 x 1800mm

HEF706 4 Tier - 1200 x 400 x 1800mm

HEF707 4 Tier - 1500 x 400 x 1800mm

HEF708 4 Tier - 900 x 600 x 1800mm

HEF709 4 Tier - 1200 x 600 x 1800mm

HEF710 4 Tier - 1500 x 600 x 1800mm



STAINLESS STEEL SERVICE TROLLEYS

Stainless Steel Service Trolleys

Ideal for hotels, restaurants & general catering establishments.

- Pressed tops
- No dirt traps, for easy cleaning
- Supplied flat packed – self-assembly required
- 4 castors with bumpers, 2 braked



2 Tier Models

HEF976 710 x 405 x 930mm

HEA128 860 x 535 x 930mm

3 Tier Models

HEF977 710 x 405 x 930mm

HEA129 860 x 535 x 930mm



GASTRONORM TROLLEYS

Self-Assembly Gastronorm Trolleys

The Connecta range of gastronorm trolleys offers an easy & safe method of transportation of food trays within the kitchen area. Units take full size 1/1 gastronorm pans securely and are mounted on castors, for ease of mobility.

- Stainless steel construction
- Supplied flat pack-easy to assemble
- Fits GN sizes 1/1, 1/2, 1/3 and 2/3 (65mm deep max)
- 4 castors with bumpers, 2 braked

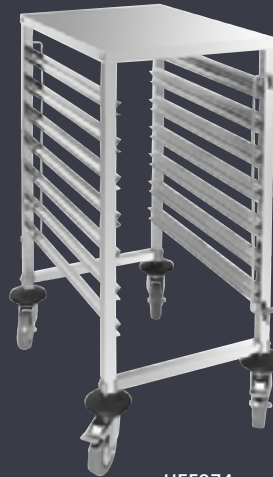

HEF974



HEF975



HEA130

Self-Assembly Gastronorm Trolleys

HEF974 7 Tier capacity, with work top - 610 x 450 x 900mm

HEF975 15 Tier capacity - 557 x 380 x 1700mm

HEA130 20 Tier x 1/1 GN - 380 x 557 x 1700mm



The logo features the Bunzl logo on the left, which consists of three horizontal bars above the word 'BUNZL'. To the right of this is the word 'LOCKHART' in a large, bold, sans-serif font. Below 'LOCKHART' is the phrase 'Catering Equipment' in a slightly smaller, bold, sans-serif font. At the bottom of the logo is the phrase 'Exclusive Brands' in a bold, sans-serif font. All text is white and set against a dark blue rectangular background.

BUNZL **LOCKHART**
Catering Equipment
Exclusive Brands

All Exclusive Brands are designed and distributed exclusively by Bunzl Lockhart Catering Equipment.
For more information call 03701 678678 or visit lockhart.co.uk

Head Office: Bunzl Lockhart Catering Equipment, Lockhart House, Brunel Road, Theale, Berkshire, RG7 4XE.

Terms & Conditions: All specifications detailed are correct at the time of going to press, errors and omissions excepted,
but are subject to alteration by us without prior notice. A copy of our full terms & conditions is available on request.